

# Thuraya X5-Touch

## User Guide



# Table of Contents

## Basics

- 3 Before you start
- 8 Device layout and functions
- 10 Notification icons
- 11 Battery
- 13 SIM cards
- 16 Turning on and connecting to the network
- 18 Phone
- 26 Contacts
- 31 Messages
- 32 Memory card (microSD card)

## Apps and features

- 34 Installing or uninstalling apps
- 35 Navigation
- 40 SOS
- 42 Tracking
- 47 Other apps

## Settings

- 48 Wi-Fi
- 48 Bluetooth
- 48 NFC
- 49 Data services
- 57 Display
- 58 Software update
- 59 Multi-function button
- 59 Screen capture

## Appendix

- 60 Maintaining your Thuraya X5-Touch
- 61 Troubleshooting
- 65 Thuraya Short Codes
- 67 Frequency Bands
- 67 Specifications
- 68 Certification / Compliance / Warranty

# Basics

## Before you start

The X5-Touch is a satellite and GSM phone with dual-SIM capability. Please make yourself familiar with the safety measures and user instructions in this manual before you start using your Thuraya X5-Touch. This will help you to get the most out of your phone.

## For your safety

The following guidelines will help you to use your Thuraya X5-Touch safely.



### SWITCH ON SAFELY

Do not switch on the phone where wireless phones use are prohibited or when it may cause interference or danger.



### SWITCH OFF IN HOSPITALS

Follow any restrictions that are advised in a hospital. Switch off the phone near medical equipment.



### ROAD SAFETY COMES FIRST

Obey all local laws. Always keep your hands free to operate the vehicle while driving. Your first consideration while driving should be road safety.



### SWITCH OFF IN AIRCRAFT

Follow any restrictions. Wireless devices can cause harmful interference to aircraft's navigation and communication systems.



### AVOID POTENTIAL HEARING LOSS

To prevent possible hearing damage, do not listen at high volume levels for long periods.

## Genuine accessories

Use only Thuraya approved accessories for your phone.

- Please be aware of dangers when using accessories which are not certified by Thuraya. Differing electrical specifications can damage your Thuraya X5-Touch and such accessories may void your device's warranty and can be potentially harmful.
- Only qualified personnel may install or repair this product.
- Do not short-circuit the battery. Short-circuiting the terminals may damage the battery or the connecting object.
- Do not expose to temperatures exceeding 90 degrees Celsius.

## Caution

- RISK OF EXPLOSION IF BATTERY IS REPLACED BY AN INCORRECT TYPE.
- DISPOSE OF USED BATTERIES ACCORDING TO THE INSTRUCTIONS.
- USE ONLY THURAYA-APPROVED CHARGERS, BATTERIES, AND CABLES. UNAPPROVED CHARGERS OR CABLES CAN CAUSE THE BATTERY TO EXPLODE OR DAMAGE THE DEVICE.
- CONNECTING THE CHARGER IMPROPERLY MAY CAUSE SERIOUS DAMAGE TO THE DEVICE. ANY DAMAGE CAUSED BY MISUSE IS NOT COVERED BY THE WARRANTY.
- WHEN FLYING, MAKE SURE THE DEVICE IS TURNED OFF DURING TAKEOFF AND LANDING. AFTER TAKEOFF, YOU CAN USE THE DEVICE IN FLIGHT MODE IF ALLOWED BY AIRCRAFT PERSONNEL.

## Taking care of your Thuraya X5-Touch

The suggestions below will help you to maintain your phone in good condition and to protect your warranty coverage.

- If your device gets wet inside, remove the battery immediately and allow the device to dry completely before replacing it. Liquids or moisture can contain minerals that can damage electronic circuits.
- Do not use or store the device in dusty or dirty areas. Its moving parts and electronic components can be damaged.
- Do not store the device in very hot areas. High temperatures can shorten the life of the device and damage batteries.
- Do not store the device in very cold areas. When the device returns to its normal temperature, moisture can form inside the device and can damage electronic circuit boards.
- Do not attempt to open the device other than as instructed in this guide.
- Unauthorized antennas, modifications, or attachments could damage the device and may violate regulations governing radio devices.

## Precautions for Thuraya X5-Touch

Your Thuraya X5-Touch is IP67 rated which means it is dust tight and submersible in water up to 1 meter. To ensure proper protection, make sure the following parts are assembled properly:

- USB cover

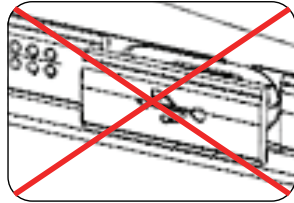
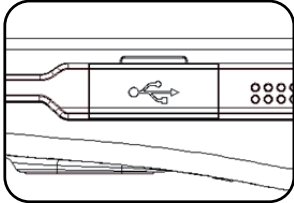

- Battery cover

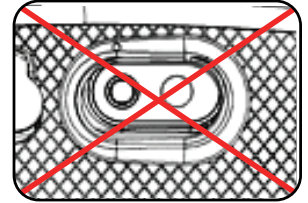
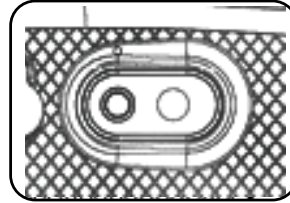

- Earphone jack cover

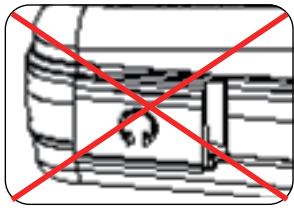
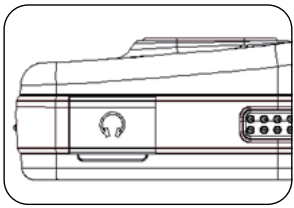

- Antenna jack cover

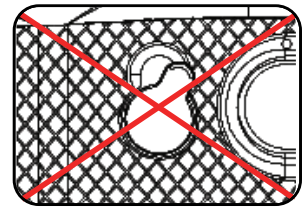
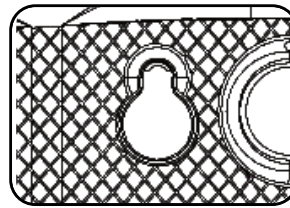

If these parts are not attached properly, it may cause water or dust ingress resulting in a malfunction.

The IP rating of the device does not make it resistant to all kinds of liquid. Pressurised water and salt/sea water can harm the phone even with a high IP rating.

## Unpacking your Thuraya X5-Touch

Your package contains the following items:



Handset



Battery

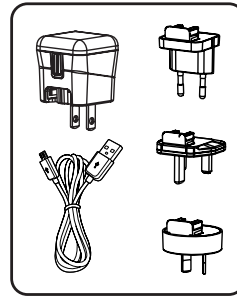

Travel Charger

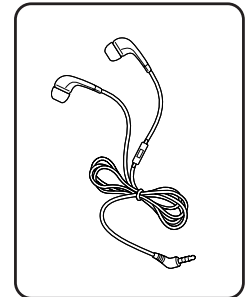

Earphone

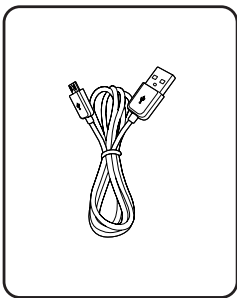

USB-C Data cable



USB disk

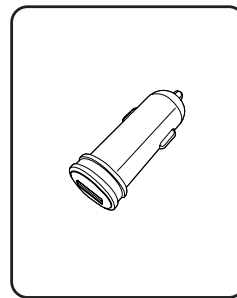

Car charger

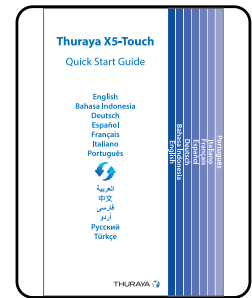

Quick start guide

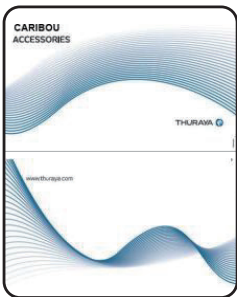

Accessories card

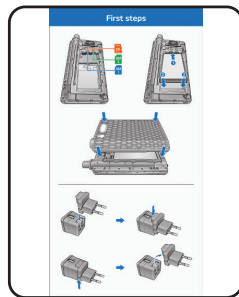

Infosheet



*Optional accessory:  
USB-C adaptor*

*If you want to use an external Micro-USB charger*



- You can purchase additional accessories from your local Thuraya retailer. Make sure they are compatible with the device before purchase.
- Use only Thuraya-approved accessories. Using unapproved accessories may cause performance problems and malfunctions that are not covered by the warranty.

# Device layout and functions





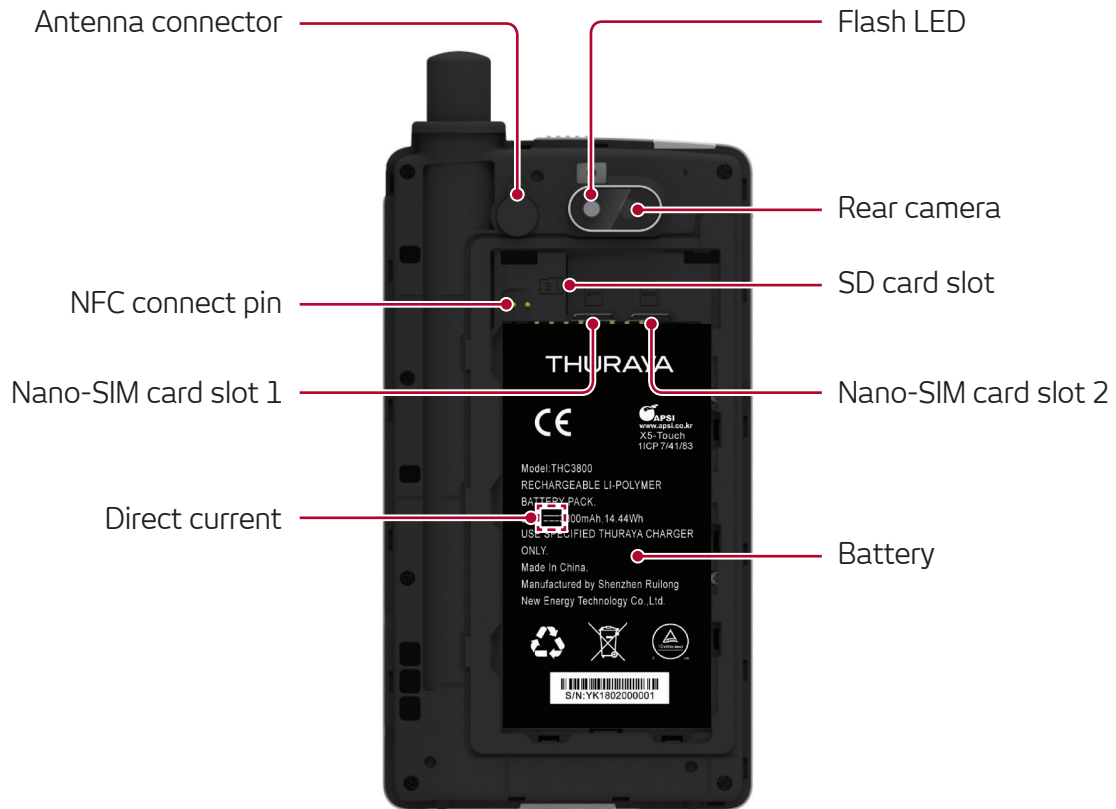

Connectivity problems and battery drain may occur in the following situations:

- If you attach metallic stickers on the antenna area of the device
- If you attach a device cover made with metallic material to the device
- If you cover the device's antenna area with your hands or other objects while using certain features, such as calls or mobile data connection

# Notification icons

Icon	Meaning	Icon	Meaning
	Network signal strength		Sending files
	No signal		Downloading files
	Wi-Fi		FM Radio
	Wi-Fi networks available		Screen capture
	Personal Wi-Fi Hotspot		Battery level
	Bluetooth		Battery level low or battery temperature is too high/low
	No SIM card		Earphone connected
	SD card		Cast
	Call in progress		Using location services
	Call on hold		Vibration
	Call barring active		Alarms only or Priority only
	Call forward active using SIM1		Total silence mode
	Call forward active using SIM2		Airplane mode
	Missed call		Data saver mode
	Speakerphone		Alarm
	Call muted		Timer
	SOS call		Stopwatch
	Fax call		GmPRS active
	New SMS or MMS		Circuit switched satellite data call
	SMS/MMS not sent/received		
	USB-cable inserted		

# Battery

## Charging the battery

Charge the battery before using it for the first time or when it has been unused for extended periods.



To save energy, unplug the charger from the electric socket when not in use.

- 1 Connect the USB-C cable to the travel charger.
- 2 Plug the cable into the device's USB-C jack.
- 3 Plug the travel charger into an electric socket.
- 4 After fully charging, disconnect the cable from the device. Then, unplug the charger from the electric socket.



## Optional: Fast charging

The device has a built-in fast charging feature. You can charge the battery more quickly while the device or its screen is turned off.

### About Fast charging

- Fast charging uses battery charging technology that charges the battery faster by increasing the charging power. The device supports Qualcomm Quick Charge 3.0.
- To use Fast charging on your device, connect it to a battery charger that supports Adaptive fast charging or Quick Charge 3.0.



- You cannot use the built-in fast charging feature when you charge the battery using a standard battery charger.
- If the device heats up or the ambient air temperature rises, the charging speed may decrease automatically. This is a normal operating condition to prevent damage to the device.

# SIM cards

The dual-SIM capability of the X5-Touch allows you to insert nano-SIM cards for satellite services and GSM services.



The phone can be used with one or two SIM cards, either in the SIM 1 slot, in the SIM 2 slot, or in both.

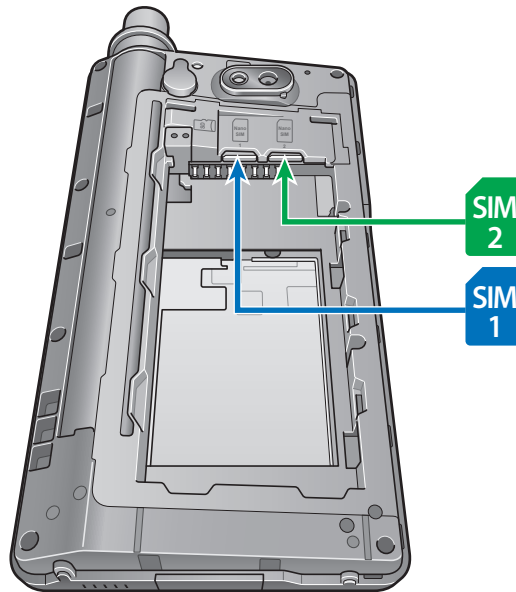

## Inserting the SIM card

- 1 Open the battery cover and remove the battery
- 2 Insert the SAT SIM card into the SIM1 slot with the gold-colored contacts facing downwards. The GSM SIM card can be inserted in the SIM 2 slot. The SIM cards have been inserted fully when you hear them click.



To remove the SIM cards, push them further in until you hear the click again, and then pull them out.

## SIM card settings

Activate your SAT SIM, GSM SIM or both and customize the SIM card settings.

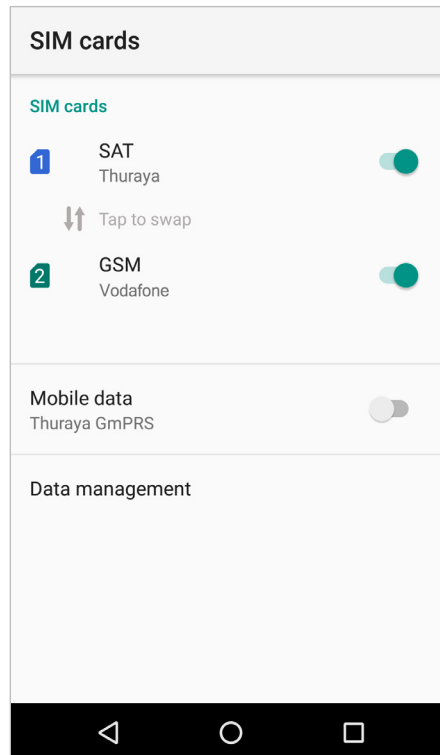

### Turning SIM on and off

By tapping the  icon next to SAT and GSM, the SAT SIM, GSM SIM or both can be turned on and off.

### Swapping networks

By tapping the  Tap to swap icon, the SAT and GSM SIM cards can be swapped without physically swapping them in the SIM slots. For example, if you have a Thuraya SIM card in SIM1 set to SAT, and a Vodafone SIM card in SIM2 set to GSM, you can swap it so that the Thuraya SIM card is used for GSM services and the Vodafone SIM card is used for SAT services. This is especially useful if you have just one GSM SIM card and wish to use it sometimes for GSM services and other times for roaming in satellite mode.



Swapping the SIM cards using this method will require the phone to restart.

### Choosing data SIM

By tapping the  icon next to Mobile data, the mobile data can be turned on and off. Choose whether to use Thuraya GmPRS or terrestrial 4G/3G/2G by tapping on the part where it says "Mobile data".

# Turning on and connecting to the network

## Turning the device on and off

Press and hold the Power button for a few seconds to turn on the device.

When you turn on your device for the first time or after performing a data reset, follow the on-screen instructions to set up your device.

To turn off the device, press and hold the Power button, and then tap **Power off**.

## Connecting to the network

When the Thuraya X5-Touch is powered on, the phone will search for the network and acquire location information. Upon successful registration to the network, the phone will display the information on the home screen according to your chosen network mode. When using the phone in satellite mode, please ensure that the SAT antenna is fully extended and that you have direct line of sight to the satellite which is not obstructed by high buildings, trees or mountains. The SAT antenna does not need to be extended when using the phone in GSM mode.

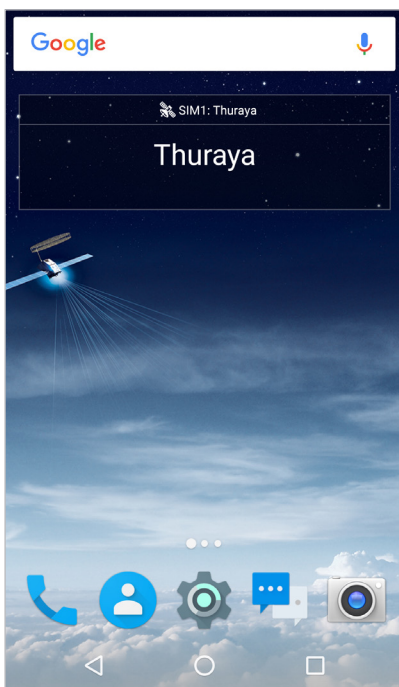

SAT only

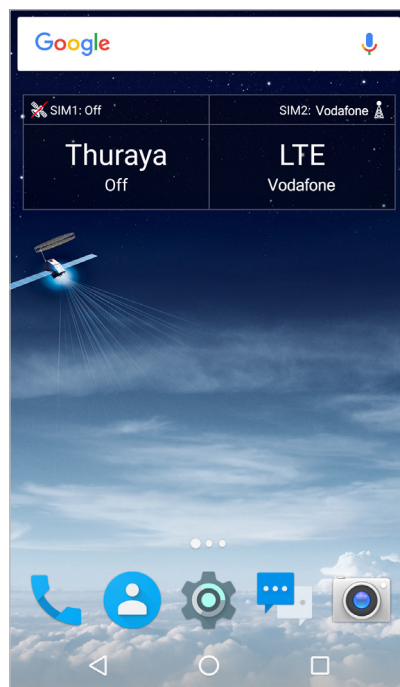

GSM only

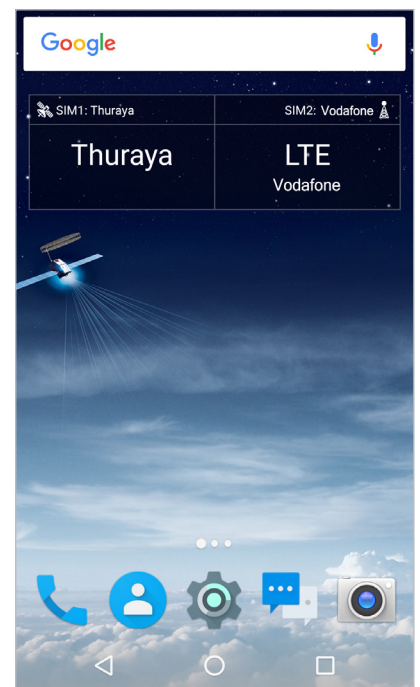

SAT & GSM





If "Location update..." is flashing in the widget along with the satellite signal icon in the notification bar, the phone is yet to receive location information which is required for use in satellite mode. Once "Location update..." disappears and the flashing stops, you will be able to make/receive calls or send/receive messages in satellite mode.

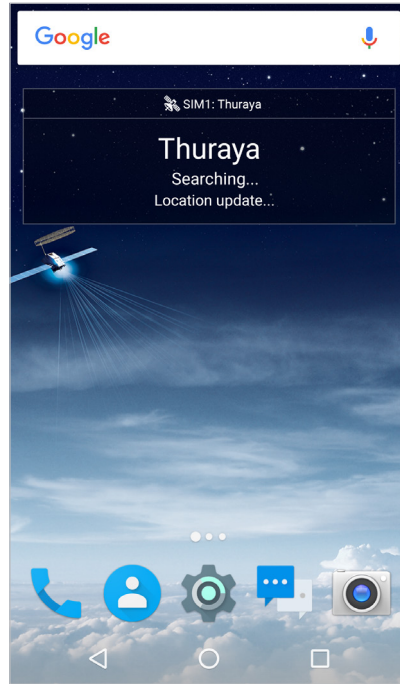

# Phone

## Making calls



To make a call, tap the  icon to launch the Phone app.

- To manually enter a phone number, tap the  icon and enter the recipient's number. Tap  to make a SAT call, or tap  to make a GSM call.

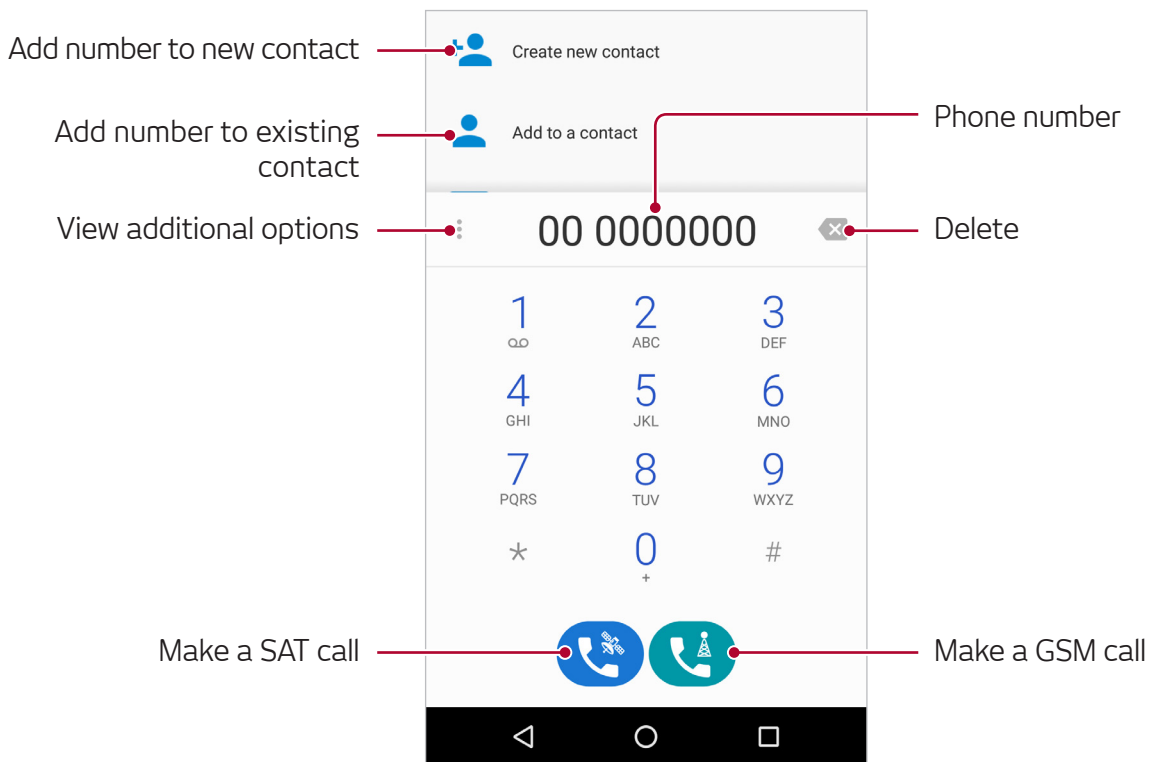

Throughout your X5-Touch, items related to the SAT network are denoted in **Blue** and items related to the GSM network are denoted in **Green**.



- To call a contact, tap the  icon, select or search for the contact, and tap the  icon to call them.

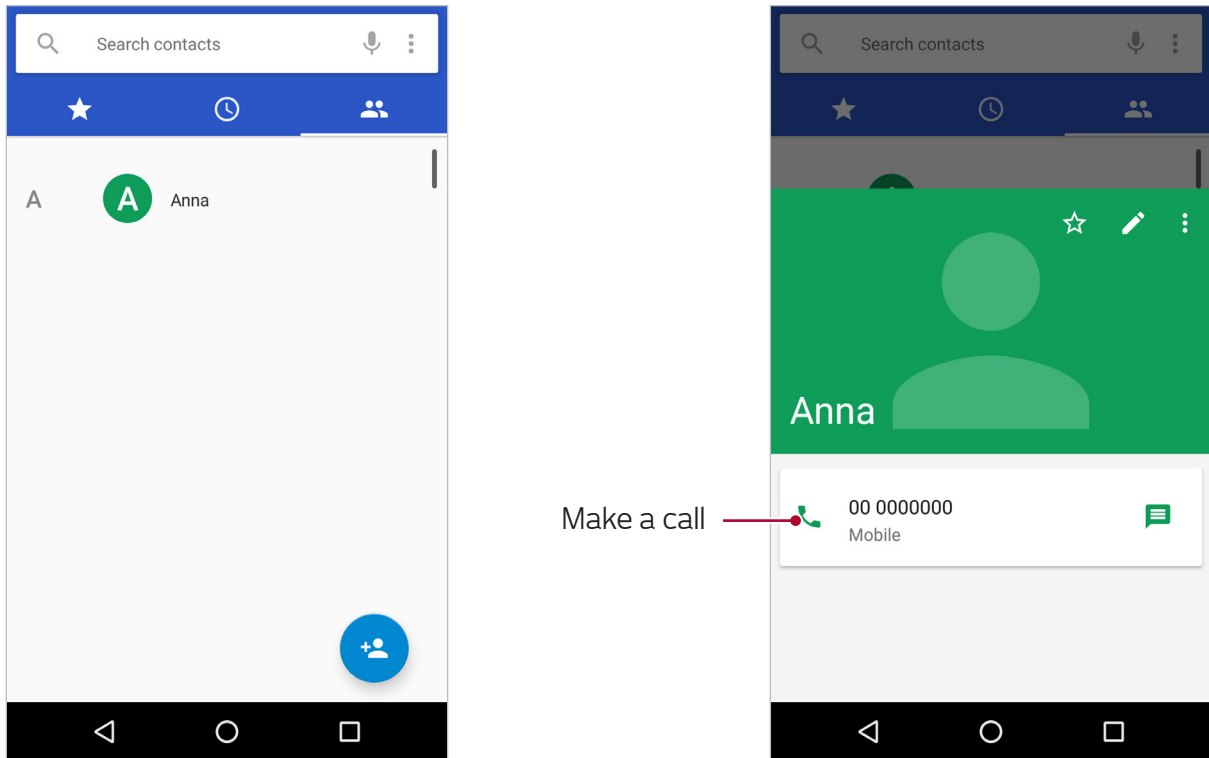

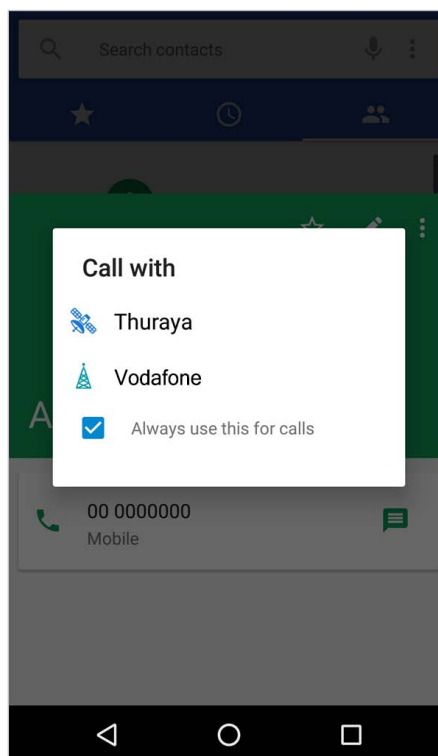

Choose whether to make a SAT call or a GSM call. By ticking the checkbox **Always use this for calls**, you can set it so that all future calls to the contact will be made using the chosen network.



To check or change the designated network for calling a contact:

- 1 Launch **Contacts** app.
- 2 Select the contact in the contact list.

If you see  or  next to the contact name, it has been set to always use the specific network to call that contact. If a network is not yet set, there will be no icon, and the contact will be called according to your selection.

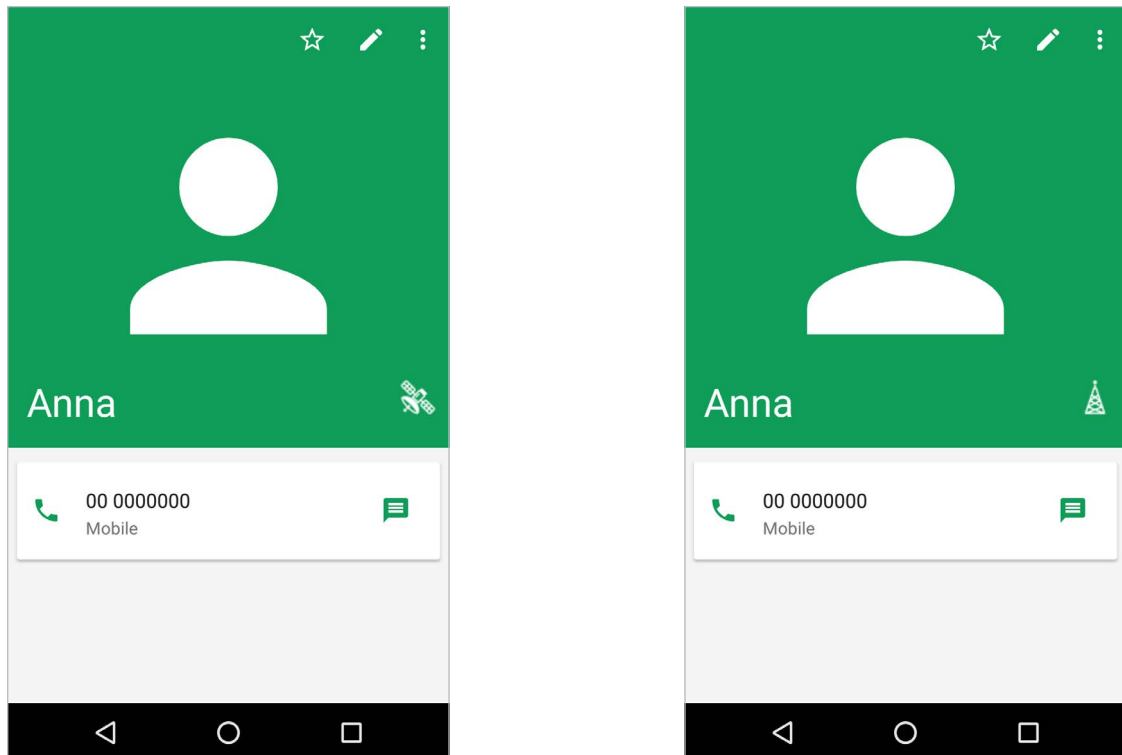

To change the current setting, tap  or  and select the preferred option.

## Using speed dial

Assign numbers to speed dial to quickly call them.

To set a number to speed dial, tap  → **Settings** → **Speed dial settings**, select a speed dial number, and then add a phone number.

To call the set number, tap and hold the corresponding speed dial number on the keypad.

## Receiving calls

### Answering a call

When a call comes in, hold and drag  to the right of the large circle.

### Rejecting a call

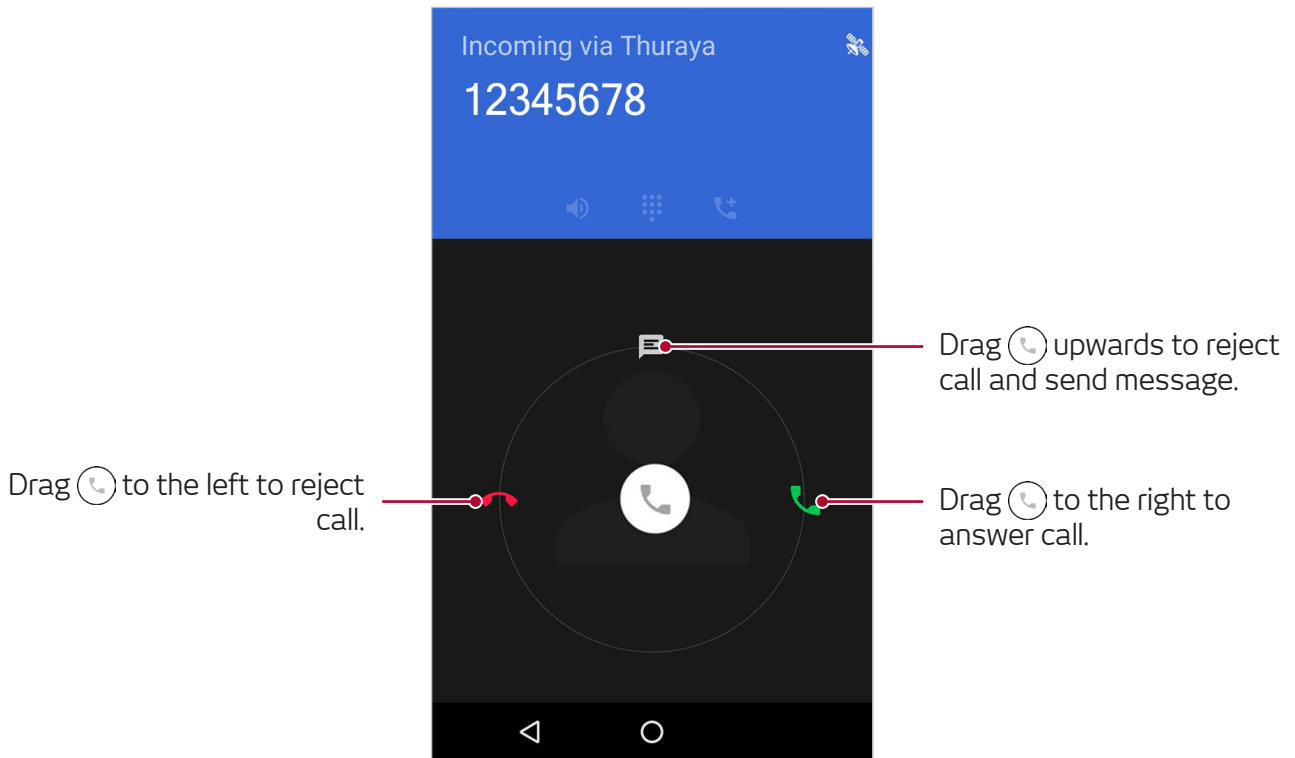

When a call comes in, hold and drag  to the left of the large circle.

To reject an incoming call and send a message to the caller, drag  to the top of the large circle and select the message to send.





## Conference calls

While in an active call on the Thuraya X5-Touch, you can make calls to other numbers and even merge multiple ongoing calls into a conference call.

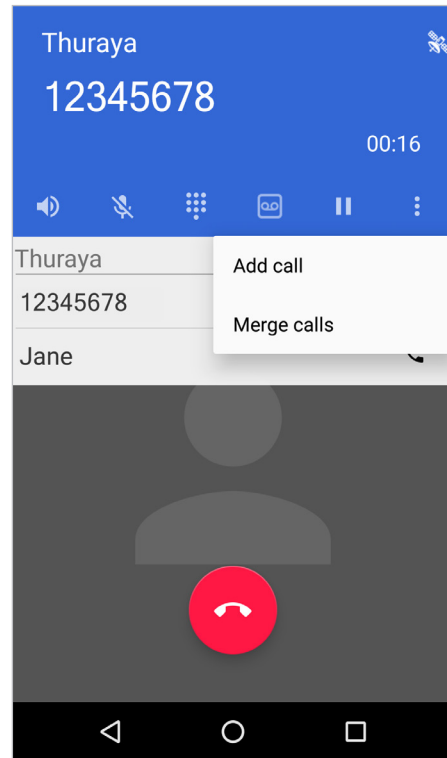
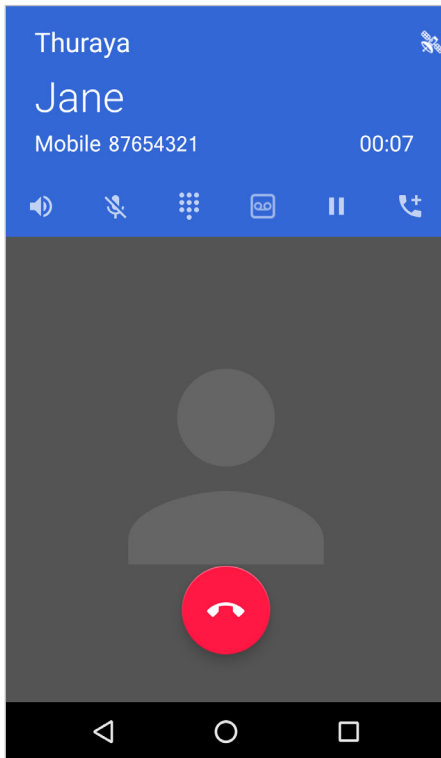
- 1 During a call, tap the  icon and either enter a phone number or select a contact from your contact list. The first call is automatically put on hold.
- 2 To add the first user into the conference call, tap the  icon and then select **Merge calls**.



3 By tapping **Manage conference call** during the conference call and then tapping the  icon you can speak with a user in private. All other calls are put on hold automatically. To disconnect a particular user tap the  icon.

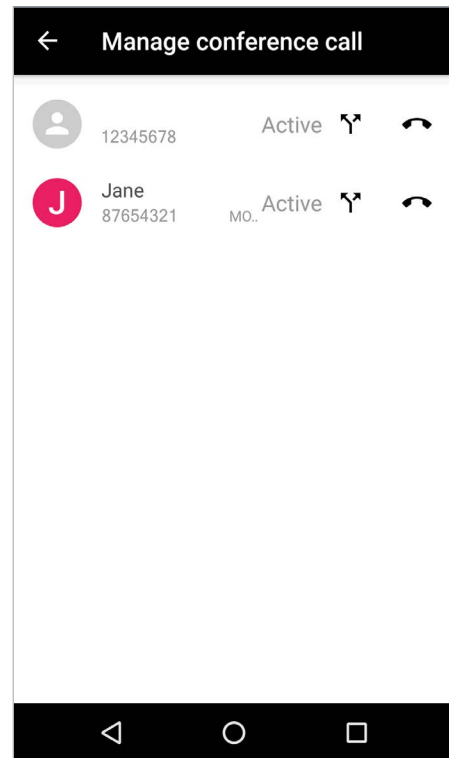
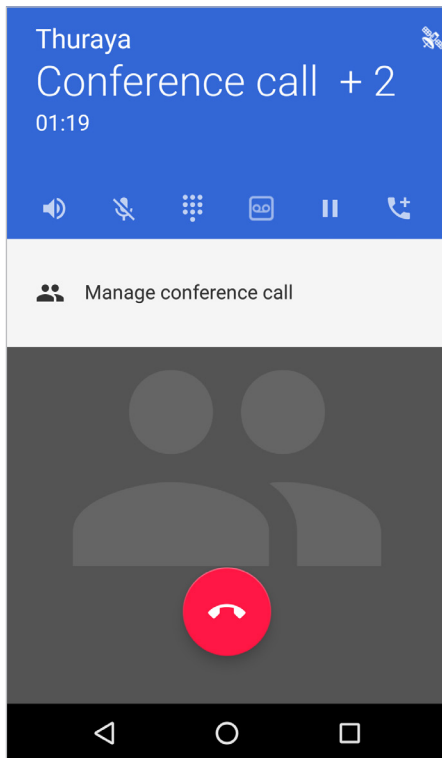

You can include up to 6 users in the conference call by repeating steps 1 and 2.



Satellite calls can be conferenced only with other satellite calls, and GSM calls can be conferenced only with other GSM calls.

## Swapping between calls

- If you are in an active SAT call, your call screen will be outlined in [Blue](#).

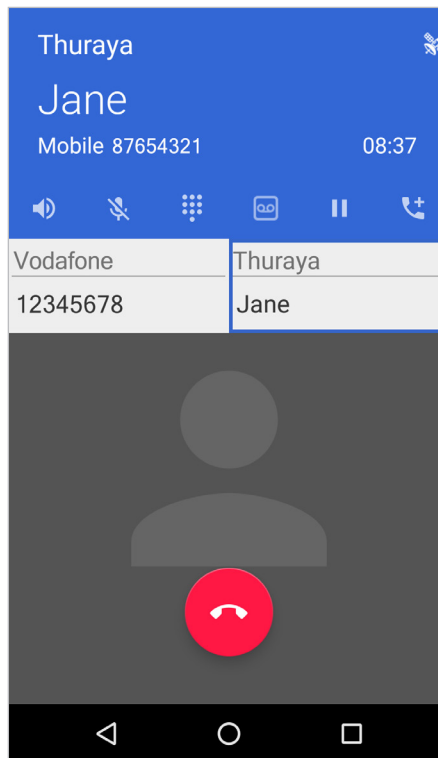

- If you are in an active GSM call, your call screen will be outlined in [Green](#).

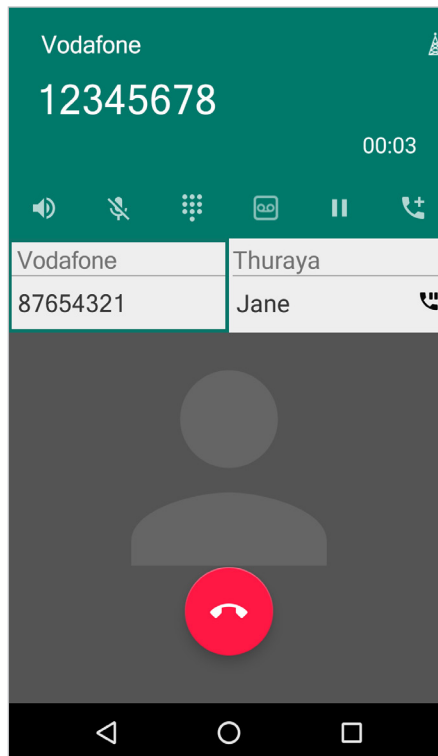







To swap between calls, click on the phone number or contact name of the person you wish to speak to, and all other calls will be put on hold automatically.



## Options during calls

The following actions are available:

-  : Turn speakerphone on or off. When using the speakerphone, keep the Thuraya X5-Touch away from your ears.
-  : Mute the microphone so that the other party cannot hear you.
-  : Show or hide the keypad.
-  : Record active call.
-  : Hold the current call.
-  : Dial a second call. The first call will be put on hold. When you end the second call, the first call will be resumed.
-  : End the current call.

# Contacts

## Introduction

Create new contacts or manage contacts on your Thuraya X5-Touch.

## Adding contacts

### Creating a new contact

- 1 Launch the **Contacts** app and tap , then select a storage location.
- 2 Enter the contact information.

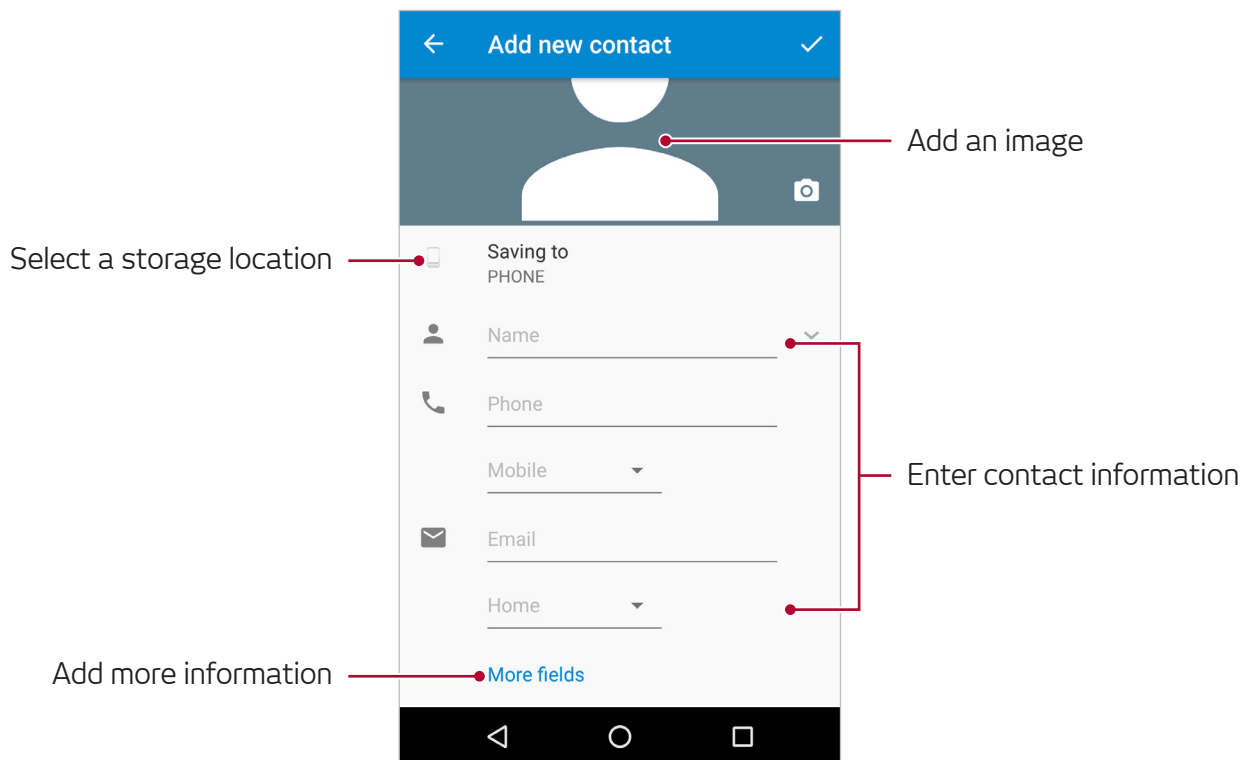

Depending on the selected storage location, the types of information you can save may vary.

- 3 Tap  to save.

## Importing/Exporting contacts

Add contacts by importing them from other locations to your Thuraya X5-Touch or backup contacts by exporting them from X5-Touch to other locations.

### Importing contacts

- 1 Launch the **Contacts** app and tap  → **Import/export**.
- 2 Select the storage location to import contacts from.
- 3 Tick contacts to import and tap **OK**.

### Exporting contacts

- 1 Launch the **Contacts** app and tap  → **Import/export**.
- 2 Select the storage location to export contacts to.
- 3 Tick contacts to export and tap **OK**.



## Searching for contacts

Launch the **Contacts** app.

Use one of the following search methods:

- Scroll up or down the contacts list.
- Drag a finger along the index at the right side of the contacts list to scroll through it quickly.
- Tap  at the top of the contacts list and then enter the contact information or phone number.

By tapping the contact's image or name you can perform one of the following actions:

-  : Add to favourite contacts.
-  : Make a voice call.
-  : Compose a message.

## Sharing contacts

You can share contacts with others through various methods.

- 1 Launch the **Contacts** app and tap → **Import/export** → **Share all contacts**.
- 2 Select contacts and tap **OK**.
- 3 Select a sharing method.



## Saving and sharing profile

Save and share your profile information.

- 1 Launch the **Contacts** app and tap **Set up my profile**.
- 2 Edit your profile, and tap ✓.
- 3 Tap ⋮ → **Share**, and select a sharing method.

## Merging duplicate contacts

When you import contacts or sync contacts with other accounts, your contacts list may include duplicate contacts. Merge duplicate contacts into one to streamline your contacts list.

- 1 Launch the **Contacts** app and tap  → **Merge contacts**.
- 2 Tick contacts and tap .

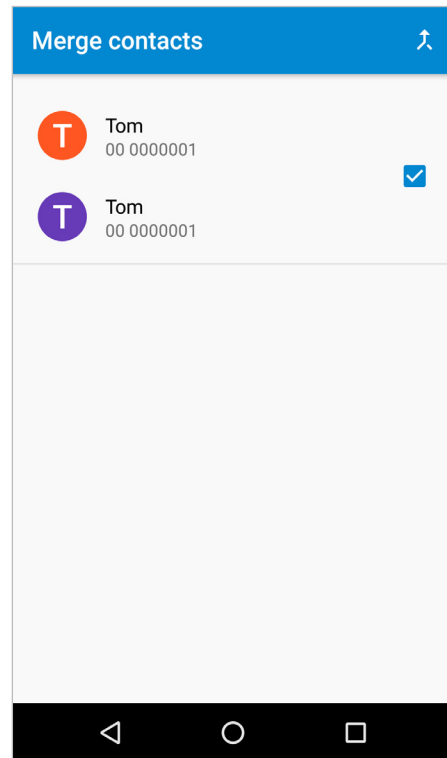
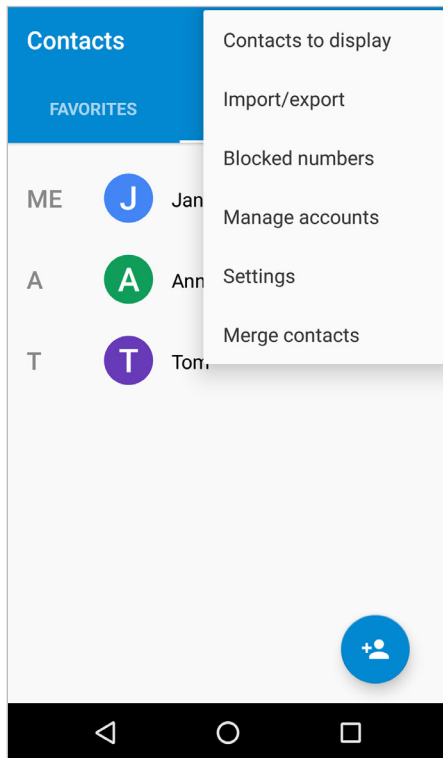

## Deleting contacts

- 1 Launch the **Contacts** app.
- 2 Touch and hold a contact in the contact list that you want to delete, then tap  → **Delete**.

To delete contacts one by one, open the contacts list and tap a contact's image or name. Then tap  → **Delete**.



## Adding favorites

Register frequently used contacts as favorites.

- 1 Launch the **Contacts** app.
- 2 Select a contact and tap .

To see all favorites, tap **FAVORITES**.

## Creating groups



- 1 Launch the **Contacts** app and tap **GROUPS**.
- 2 Select a group and tap  → **Edit** and enter contact name to add members.
- 3 Tap  to save the group information.

To add groups, tap  → **Add Group** and enter a new group name.

To move group members, select a group, tap  → **Move group members**, select the contacts to be moved, tap **OK**, then select the group to move them to.

# Messages

## Sending messages

- 1 Launch the Messages app and tap the  icon to send a new message.
- 2 Add recipients, enter a message and choose if you want to send an SMS or Email.
- 3 Tap  to send a SAT message or tap  to send a GSM message.

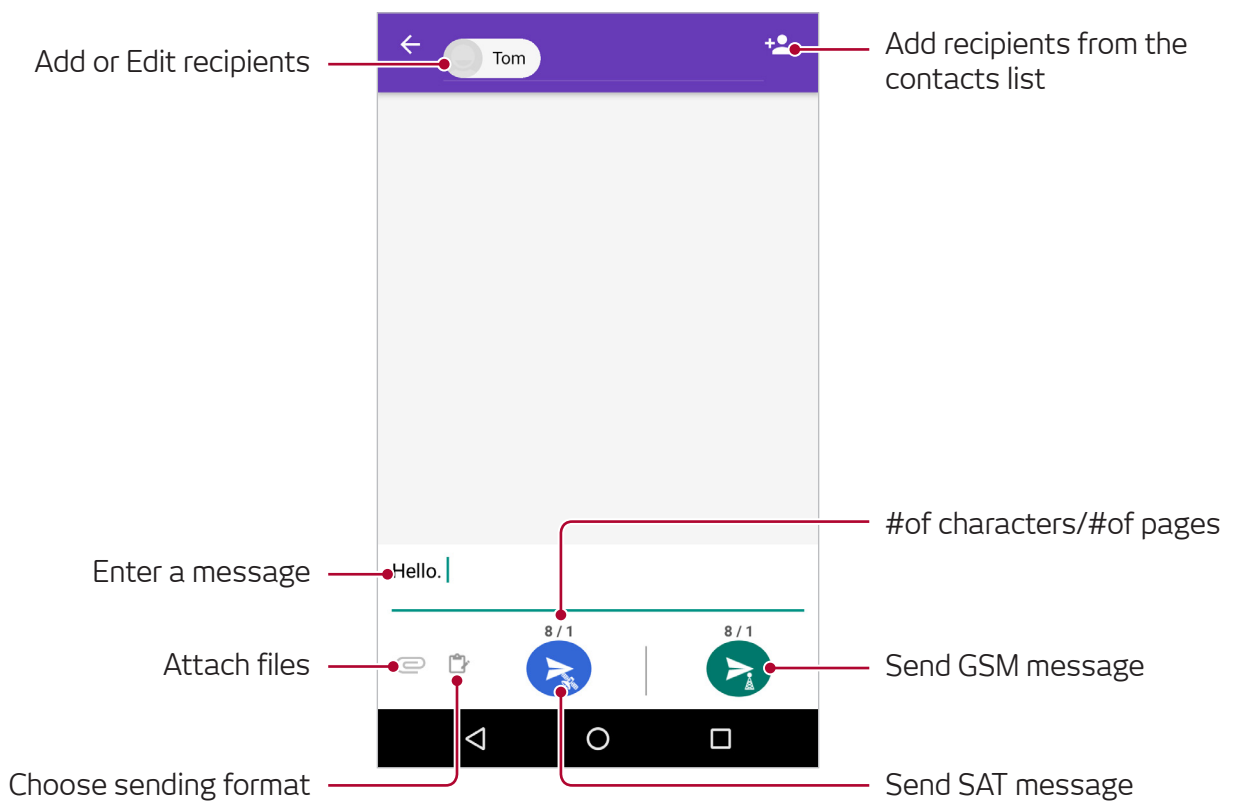

- Emails and SMSs cannot be sent as part of the same message.
- If a file is attached, the message will be sent as an MMS. Mobile data must be turned on to send an MMS and applicable data charges may apply.

# Memory card (microSD card)

## Installing a memory card

- 1 Open the battery cover.
- 2 Insert the microSD card fully into the slot with the gold-colored contacts facing downwards.



Before removing the microSD card, make sure to unmount it first from the software settings or there is a risk of your data being corrupted. To unmount, go to Settings → Storage and press the  icon.

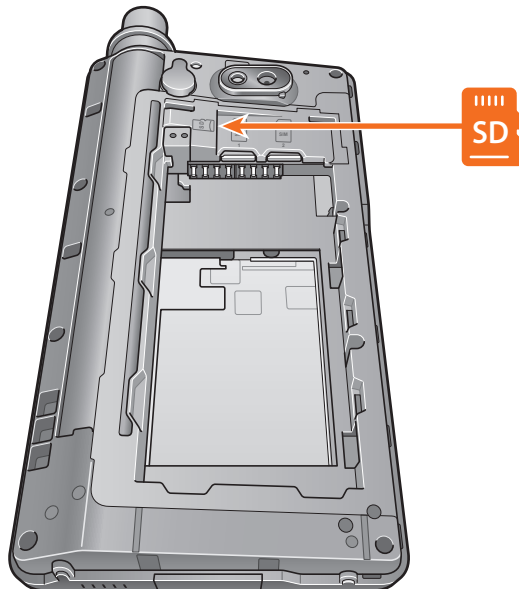



## Accessing the microSD card through the File Manager

After inserting a memory card into the Thuraya X5-Touch, to explore its files go to **File Manager** → **SD card**.

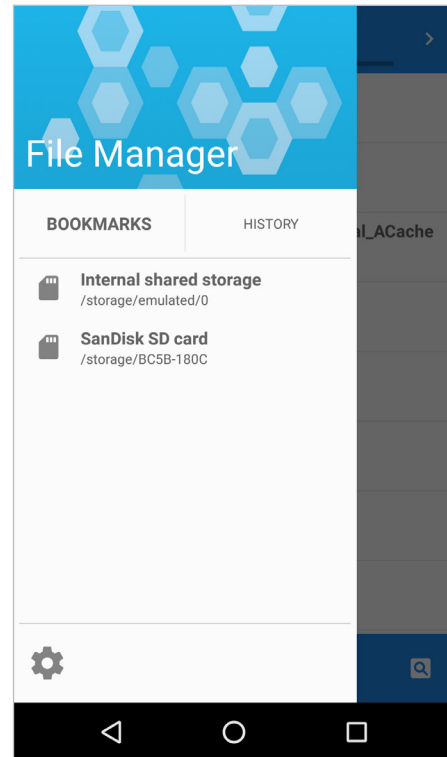
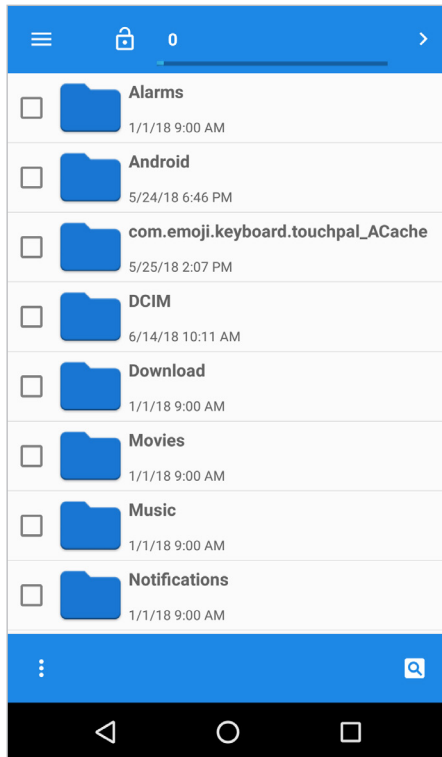

- 1 Tap the **File Manager**.
- 2 Tap the .
- 3 Tap SD card.



The Thuraya X5-Touch supports memory cards of up to 32 GB size.

# Apps and features

## Installing or uninstalling apps

### Installing apps

In addition to the pre-installed apps you can install apps from the Google Play Store or from other sources. Once an app was installed it will appear on the homescreen of the phone.

### Uninstalling apps

Tap and hold an app and drag it to **Uninstall**.



# Navigation

The navigation feature on your Thuraya X5-Touch is a powerful tool that allows you to use location information in various ways. It supports GPS, BeiDou and Glonass for maximum accuracy and flexibility.

To center the map to your current location tap on the center button.

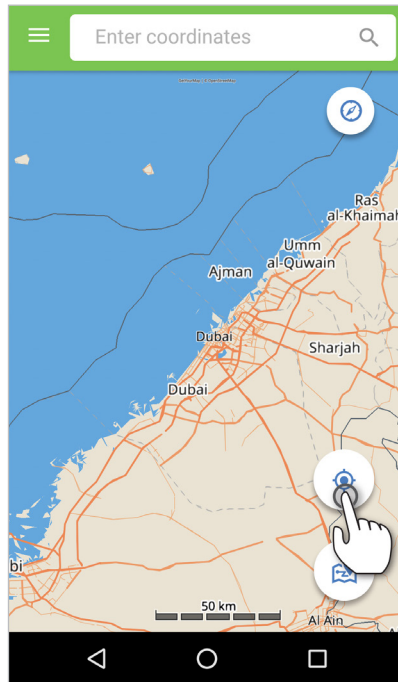

You can create waypoints by tapping and holding on the map.

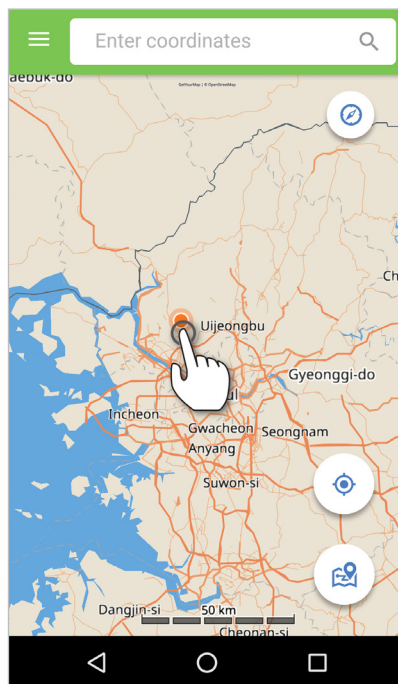

Enter waypoints to navigate to a specific position using the geomagnetic compass (see under Waypoints).

### Compass

To use the built-in compass, select the compass button in the top right of the map.

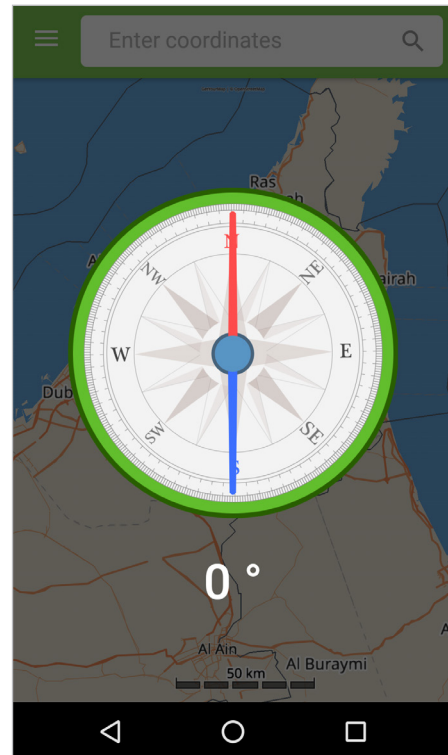

The compass uses a geomagnetic field sensor and shows the direction relative to the geographic cardinal directions where the red needle points northwards. North corresponds to  $0^\circ$  and the angles increase clockwise where east is  $90^\circ$  degrees, south is  $180^\circ$ , and west is  $270^\circ$ . The geomagnetic field sensor is independent of the orientation of the phone and measures the earth's magnetic field strength.

## Position logging

Under **Navigation** → **Position logging** you can log your position at chosen intervals while moving. The position logging data can be saved on the phone or PC according to your settings. Open the log list tab to see the position logging data.

Tap on position logging button to log your position on a map at a preset interval ranging from once every second to once an hour.

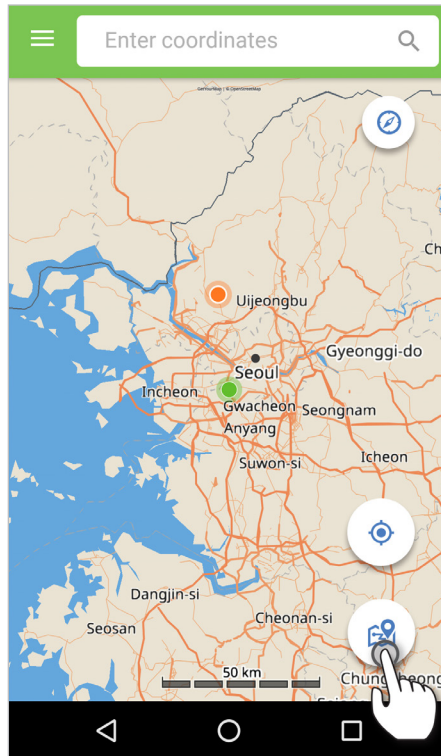

## Waypoints

A waypoint represents a specific location which can either be your current position or it can be manually entered in the form of coordinates to navigate to this waypoint. To manually add waypoints on your phone go to **Navigation** → **Waypoints** and tap → **New**.

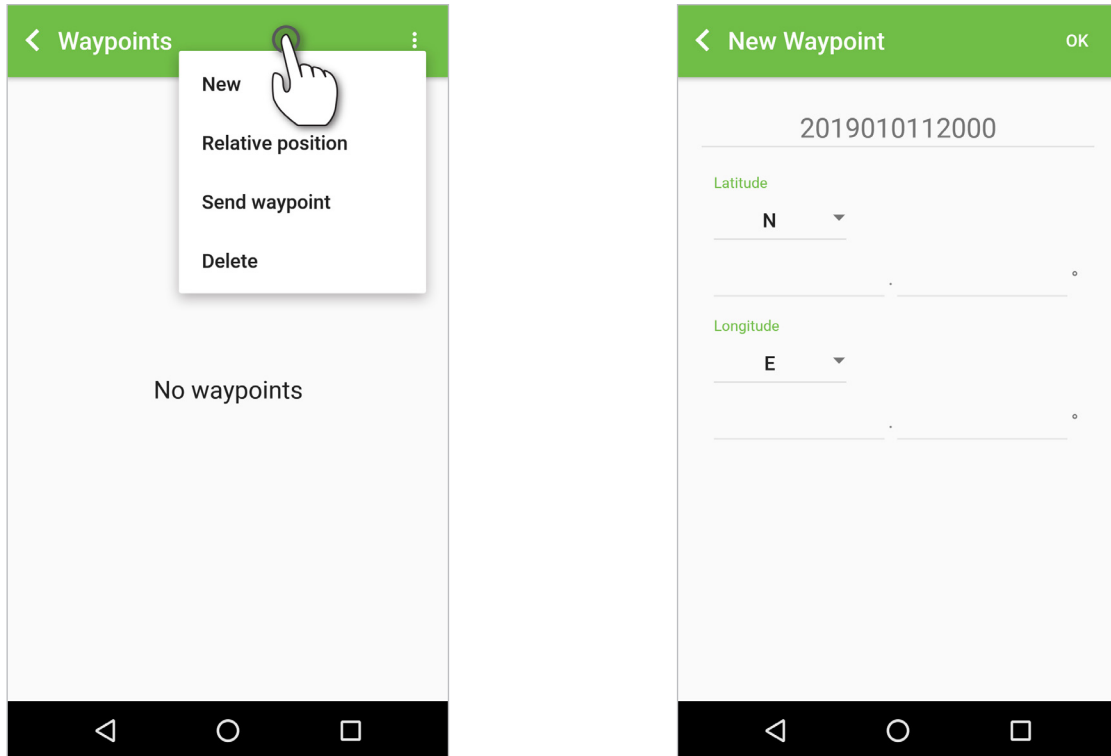

By selecting **Relative position** you will be able to compare two waypoints. When comparing two waypoints always the upper one will be the reference point and the lower one will be the comparison point. Tap **View** to see the relative position details of the two points (you can interchange the two waypoints by tapping **Invert**).

If you want to send a waypoint by SMS or email you can select **Send waypoint**.

### Send current location

To send your current location by SMS or email select **Send current location**.

### GNSS signal

To see the current sensitivity of the various navigation systems, go to **GNSS signal**.

### Find satellite

To find the location of the nearest Thuraya satellite, go to **Find satellite**.

### Connect to PC

To save the coordinates to a PC/laptop, go to **Navigation** → **Connect to PC**.  
For the PC connection a USB-C data cable is required.

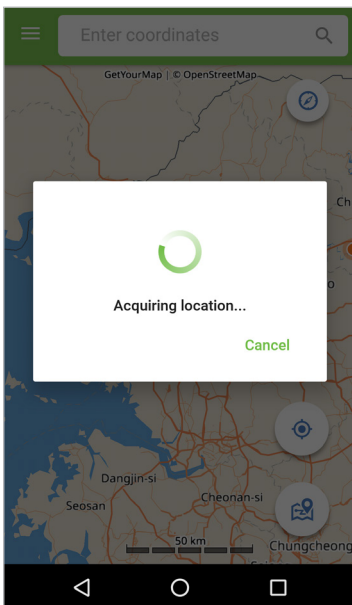

### Settings

In the settings you can change the input and output formats of the coordinates.

# SOS

The Thuraya X5-Touch allows you to make an SOS call and/or send SOS messages to pre-determined recipients either from the SOS app or directly from the SOS button on the side of the phone.

In the SOS settings you can:

- Program an SOS call recipient
- Program up to 10 SOS message recipients (SMS and email)
- Include separate SOS messages for SMS recipients and email recipients
- Choose the frequency of outgoing SOS messages (every 3 minutes to every 24 hours)
- Change the format in which your coordinates will be received

Once SOS has been set up, tap **Home** for enabling SOS Call and/or SOS Message. Once at least one of either SOS Call or SOS Message are enabled, tap SOS in the center of the screen or press the SOS button on the side of the phone for 3 seconds to activate it (the SOS icon will be shown in the status bar as per your configuration). To deactivate, tap SOS in the center of the screen again.

In the tab **Log List** you can see the list of the sent SOS messages.

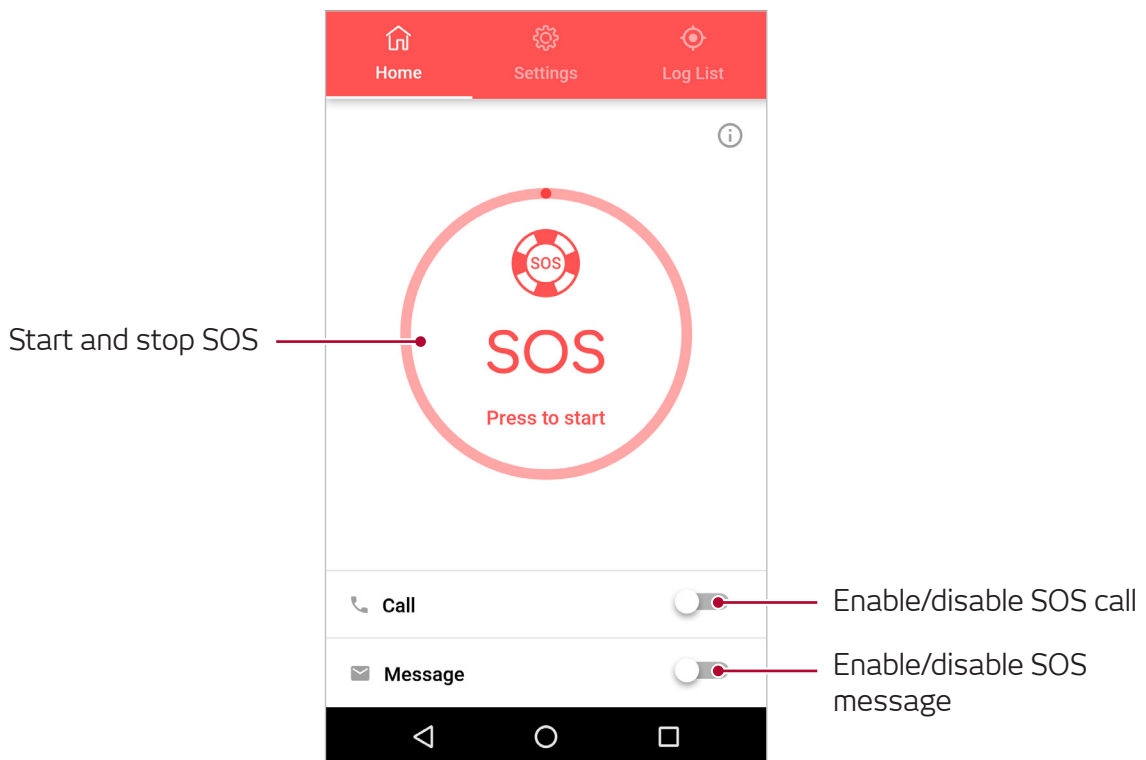



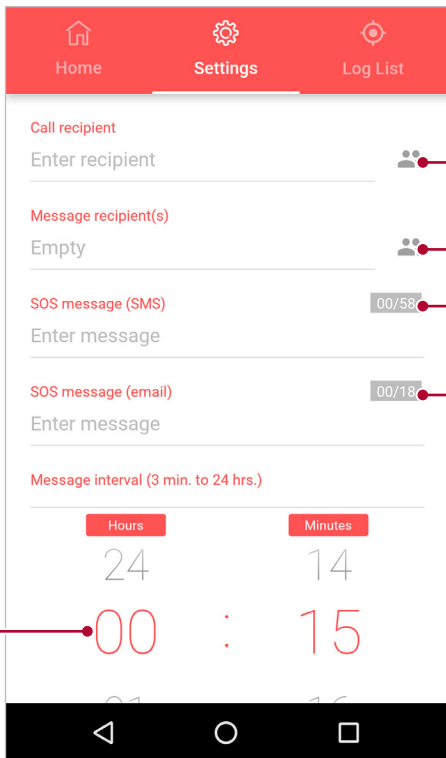



Call recipient  
Enter recipient  Only 1 recipient

Message recipient(s)  
Empty  Up to 10 recipients

SOS message (SMS)  00/58 Max. 58 characters (GMS-7)

SOS message (email)  00/18 Max. 18 characters (GMS-7)

Message interval (3 min. to 24 hrs.)

Hours Minutes

24 14

00 : 15

Message interval  
3 minute to 24 hours

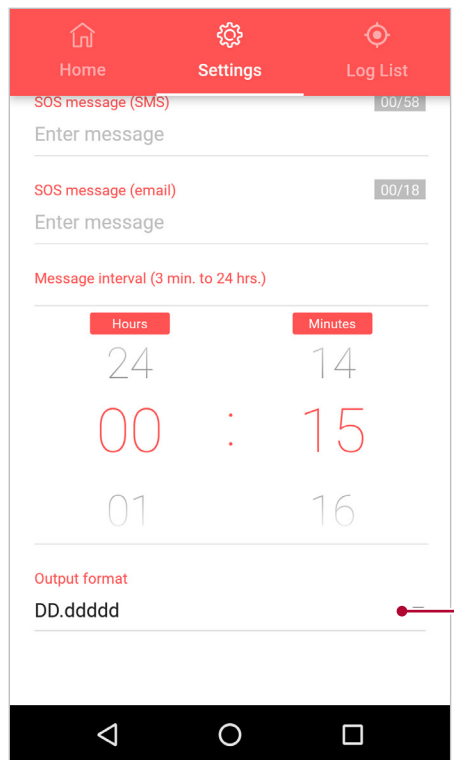

SOS message (SMS)  00/58

Enter message

SOS message (email)  00/18

Enter message

Message interval (3 min. to 24 hrs.)

Hours Minutes

24 14

00 : 15

01 16

Output format

DD.ddddd  Output format

1. DD.ddddd
2. DD/MM/SS.ss
3. DD/MM/SS
4. DD/MM.mm
5. MGRS
6. UTM
7. Google Maps



You can activate SOS even when the X5-Touch is switched off by pressing and holding the SOS button for 3 seconds.

# Tracking

The Thuraya X5-Touch can be used to send your coordinates to pre-defined numbers via SMS or email based on preset time intervals, amount of distance moved or when moving inside or outside of a preset geofence.

Under **Settings** you can program up to 10 message recipients (SMS and/or email) and you can choose the format in which your coordinates will be received.

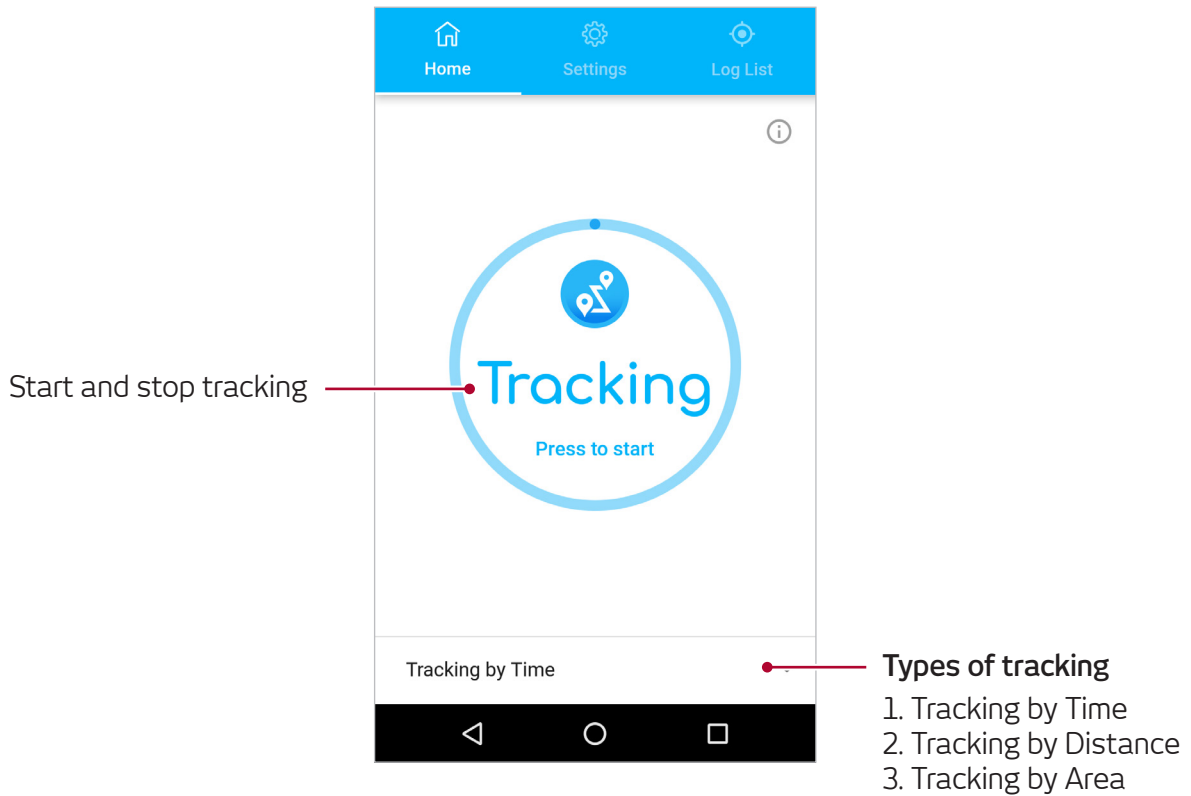

## Tracking by Time

Coordinates will be sent at preset time intervals. Choose frequency of outgoing messages (every 3 minutes to every 24 hours).

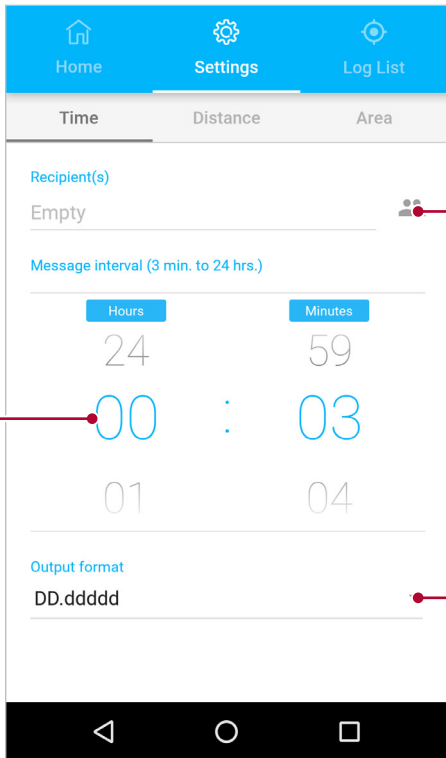

The screenshot shows the 'Settings' screen for the 'Tracking by Time' feature. The screen has a blue header with three tabs: 'Home', 'Settings', and 'Log List'. Below the header are three tabs: 'Time', 'Distance', and 'Area'. The 'Time' tab is selected. The 'Recipient(s)' field is empty, with a callout indicating 'Up to 10 recipients'. The 'Message interval (3 min. to 24 hrs.)' is set to 24 hours and 03 minutes, with a callout indicating 'Message interval 3 minutes to 24 hours'. The 'Output format' is set to 'DD.ddddd', with a callout indicating 'Output format' and a list of options: 1. DD.ddddd, 2. DD/MM/SS.ss, 3. DD/MM/SS, 4. DD/MM.mm, 5. MGRS, 6. UTM, 7. Google Maps.

**Recipient(s)**  
Empty

**Message interval (3 min. to 24 hrs.)**  
Hours: 24, Minutes: 59  
00 : 03  
01 : 04

**Output format**  
DD.ddddd

**Output format**

1. DD.ddddd
2. DD/MM/SS.ss
3. DD/MM/SS
4. DD/MM.mm
5. MGRS
6. UTM
7. Google Maps

## Tracking by Distance

Coordinates will be sent based on the distance the user has moved. Choose distance interval for outgoing messages (every 100m to every 10,000km).

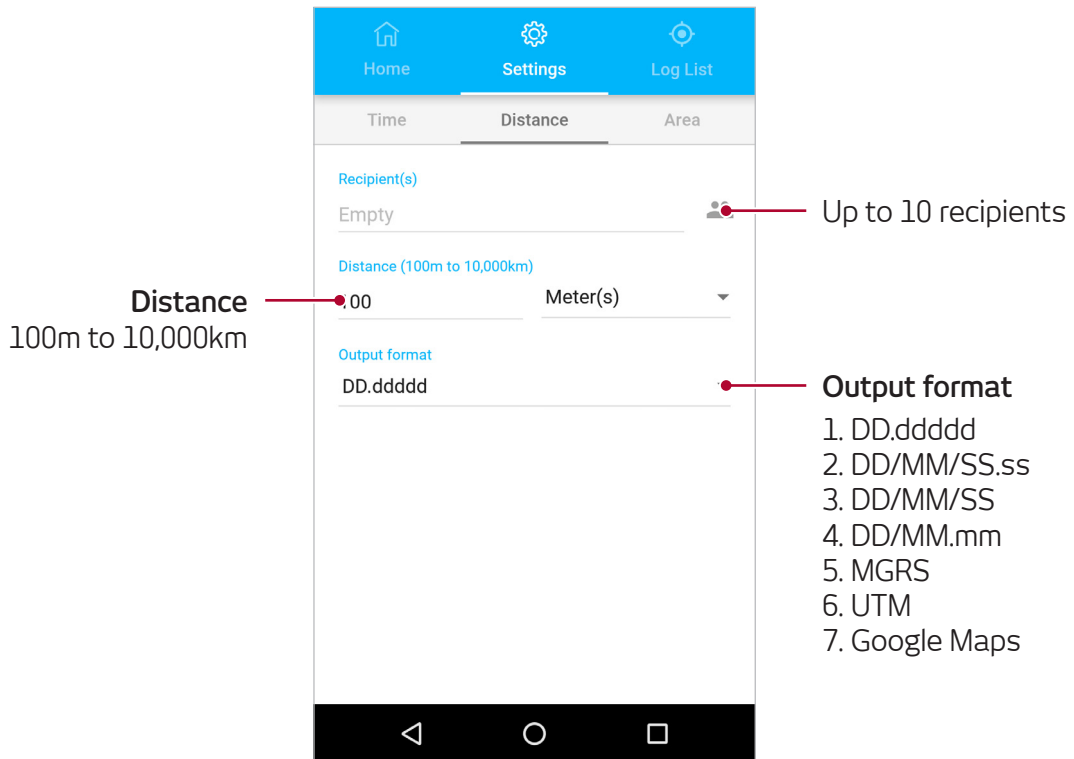

## Tracking by Area (Geofence)

Coordinates will be sent if the user moves in or out of a predesignated geofence. Choose the number of points to create the geofence (3 points to 7 points). Enter the coordinates in consecutive order to form a closed polygon. The coordinates can be chosen directly on the map by tapping and holding on the desired position, or they can be entered manually by choosing the 'Manual' option.

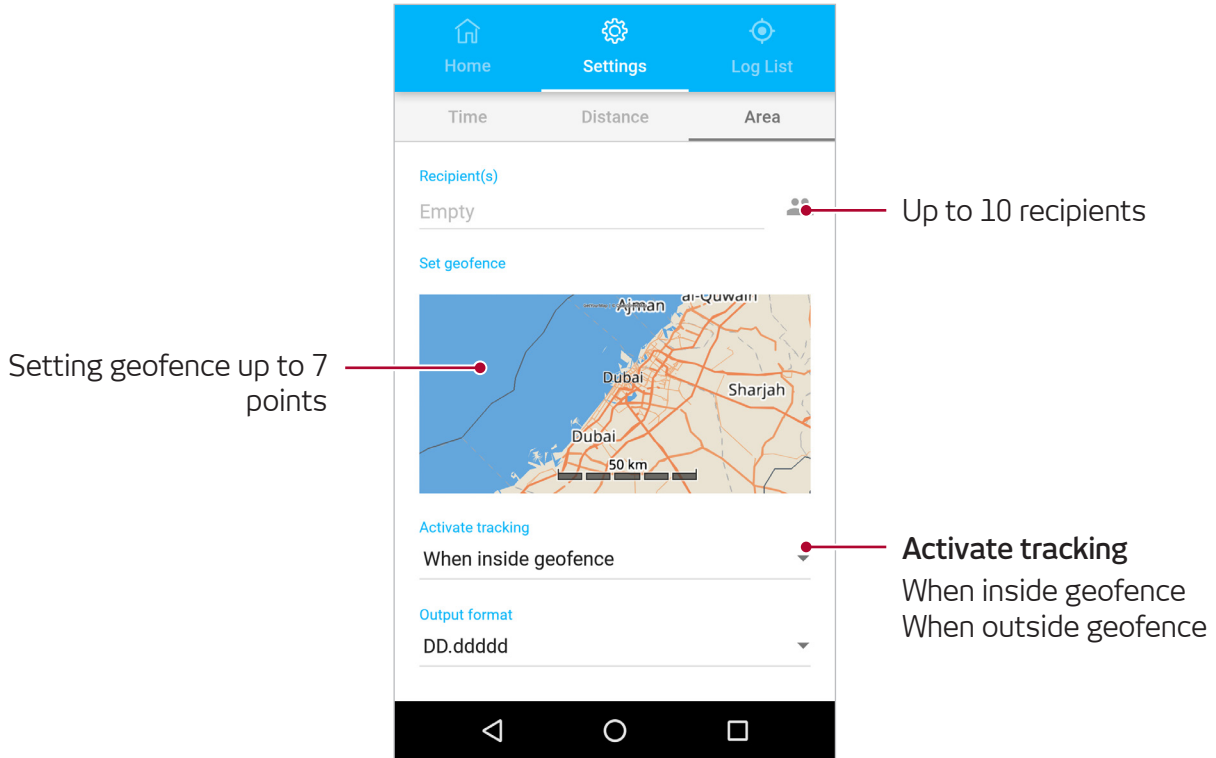

## How to use geofence:

For example, you chose to set up a geofence with 7 coordinates to form the below shown polygon and activated Tracking by Area with the option 'When outside geofence'. If you are inside the geofence, e.g. moving along the blue line, no coordinates will be sent. However, if you are outside the geofence, e.g. moving along the green line, your coordinates will be sent as outgoing messages every 3 minutes, until you reach back inside the geofence or deactivate tracking.

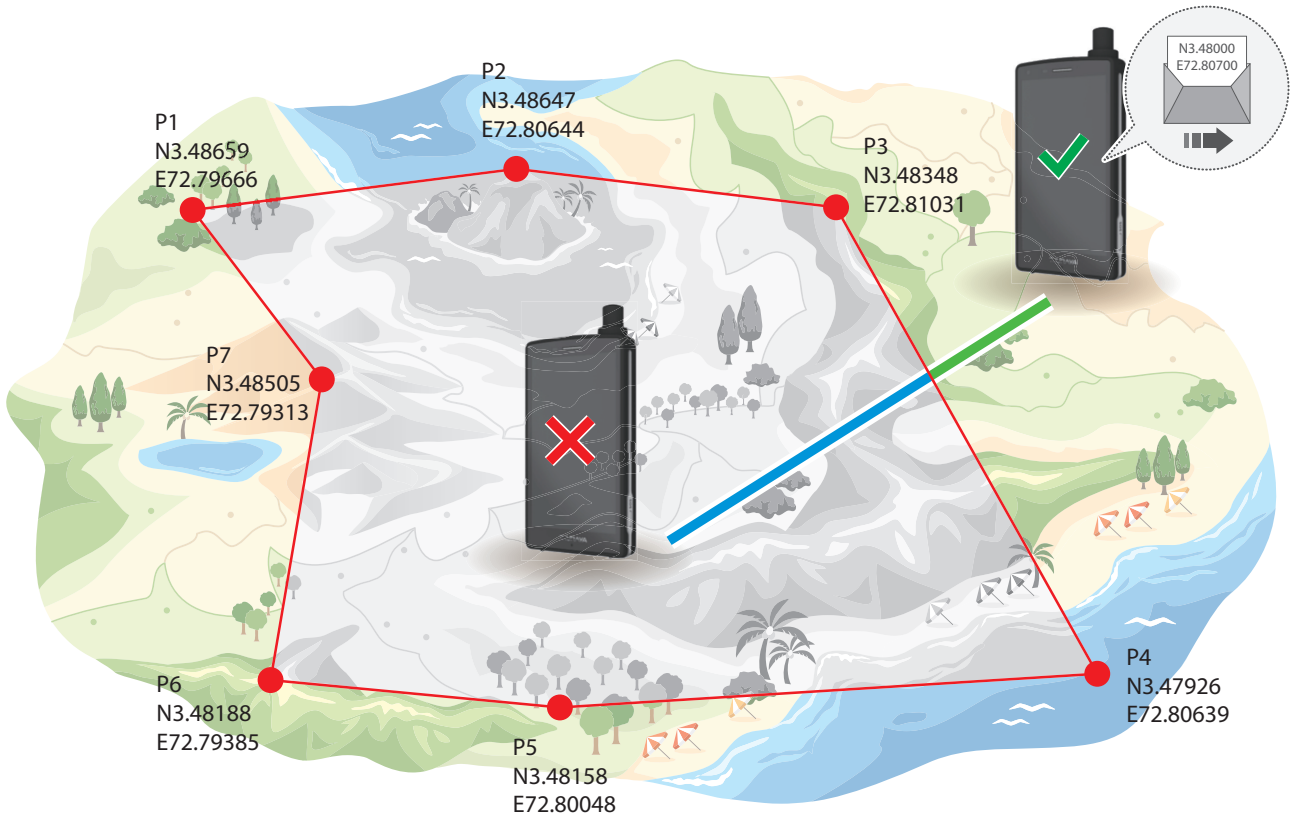

## Other apps

### Camera

Take photos and record videos using various modes and settings. To launch the camera use the following methods:

- Launch the **Camera** app from the home screen
- Press the **Power** button twice
- On the lock screen, drag the camera icon outside the circle

### Calendar

Manage your schedule by entering upcoming events or tasks in your planner.

### Sound Recorder

Make audio recordings or quick voice notes and save them to your phone.

### FM Radio

Use your phone's built in FM receiver to tune in to local radio stations.

### File Manager

Access and manage various files stored in the device. You can view files in your device or a memory card by category.

### Clock

Set **Alarms**, see **World Clock**, use **Stopwatch** and **Timer**.

# Settings

## Wi-Fi

- 1 On the **Settings** screen, tap **Wi-Fi** and then tap the switch to activate it.
- 2 Select a network from the **Wi-Fi networks** list.

Networks that require a password appear with a lock icon, enter the password and tap **CONNECT**.

## Bluetooth

- 1 On the **Settings** screen, tap **Bluetooth** and then tap the switch to activate it, the detected devices will be listed. Your device is visible to other devices while the **Bluetooth** settings screen is open.
- 2 Select a device to pair with. The devices will be connected when the other device accepts the **Bluetooth** connection request.

## NFC

Use the NFC feature to send files or contacts to other devices.

- 1 On the Settings screen, tap **More** and tap the **NFC** switch to activate it.
- 2 Tap the **Android Beam** switch to activate it.
- 3 Select an item and touch the back of your device to the back of the other device.
- 4 When **Tap to beam** appears on the screen, tap on it to send the item.



# Data services

## How to use data services on the phone

In order to use data on your Thuraya X5-Touch for your apps and messaging you have to activate the data service first. Choose whether to use data via Thuraya GmPRS or terrestrial 4G/3G/2G on the phone.

- 1 On the **Settings** screen, tap **SIM cards** and tap the **Mobile data** switch to activate it.
- 2 Select Thuraya GmPRS or terrestrial 4G/3G/2G.

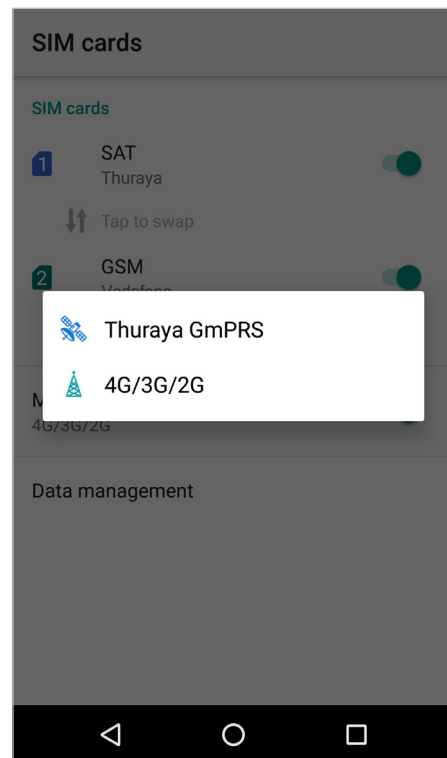
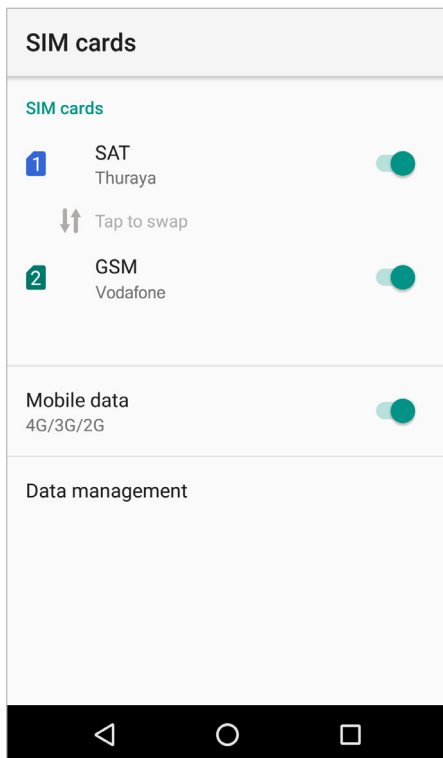

## How to use Thuraya GmPRS or terrestrial 4G/3G/2G on the computer

Via USB tethering:

- 1 Download the latest Thuraya X5-Touch driver package from the Thuraya website or the included USB.
- 2 Run the setup file; the required drivers will be installed.
- 3 Connect the X5-Touch to a computer using a USB data cable.
- 4 On the **Settings** screen, tap **More**, tap **Tethering & Personal Hotspot** and tap the **USB tethering** switch to activate it.

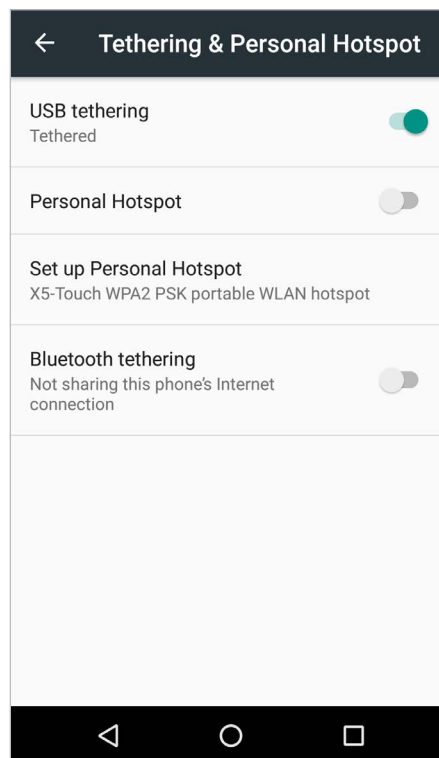

## How to use Thuraya Circuit Switched Data on the computer

Via Dial-up network (also an alternative option for Thuraya GmPRS and terrestrial 4G/3G/2G which doesn't share bandwidth with the X5-Touch):

### Step 1

- Download the latest Thuraya X5-Touch driver package from the Thuraya website or the included USB.
- Run the setup file; the required drivers will be installed.
- Go to **Settings** → **SIM cards** and turn the **Mobile data** switch off.

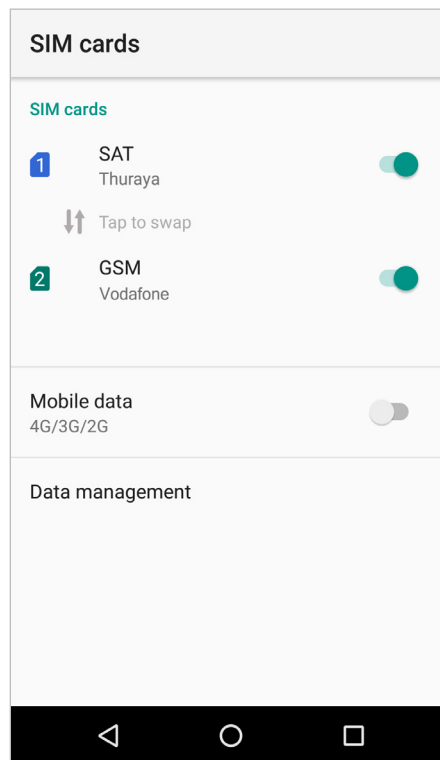

### Step 2

- Connect the X5-Touch to a computer using a USB data cable.

For satellite (GmPRS or Circuit Switched) data:

- Select or right click on **Start** and go to **Control Panel** → **System** → **Device Manager**.
- Check the USB serial port of Thuraya X5-Touch (e.g. COM40).
- Select or right click on **Start** and go to **Control Panel** → **Phone and Modem**.
- Select the **Modems** tab and press **Add**.
- Check the box of **"Don't detect my modem; I will select it from a list."** and press **Next**.
- Select and press **Standard 56000 bps Modem** and press **Next**.
- Select the USB serial port that you previously checked above and press **Next**.
- When the modem installation is completed, press **Finish**.

For GSM (4G/3G/2G) data:

- Select or right click on **Start** and go to **Control Panel** → **Phone and Modem**.
- Go to the **Modems** tab, select the **Thuraya X5-Touch HS-USB Modem** and press **OK**.

### Step 3

Create a dial-up connection and in the dial-up phone number field, enter the access number **\*99#** (for Thuraya GmPRS and terrestrial 4G/3G/2G) or **1722** (for Thuraya Circuit Switched Data):

For Windows 7:

- Select **Start** → **Control Panel** → **Network and Sharing Center**.
- Select and press **Set up a new connection or network**.
- Select and press **Set up dial-up connection** and then **Next**.
- Enter **\*99#** or **1722** on the Dial-up phone number field. (Optionally you can enter user name and password).
- Enter connection name and press **Connect**.
- Use the Internet via the newly created dial-up connection.

For Windows 8/8.1:

- Right click on **Start** and select **Control Panel** → **Network and Sharing Center**.
- Select and press **Set up a new connection or network**.
- Select and press **Set up dial-up connection** and then **Next**.
- Select and press **Connect to the network** and then **Next**.
- Select and press **No, create a new connection** and then **Next**.
- Select and press **Dial-up connection** and then **Next**.
- Enter **\*99#** or **1722** on the Dial-up phone number field. (Optionally you can enter user name and password).
- Enter connection name and press **Connect**.
- Use the Internet via the newly created dial-up connection.

For Windows 10:

- Right click on **Start** and select **Control Panel** → **Network and Internet** > **Network and Sharing Center**.
- Select and press **Set up a new connection or network**.
- Select and press **Connect to the Internet** and then **Next**.
- Select and press **Set up a new connection anyway**.
- Select and press **No, create a new connection then Next**.
- Select and press **Dial-up (Connect using a dial-up modem or ISDN)**.
- Enter **\*99#** or **1722** on the Dial-up phone number field. (Optionally you can enter user name and password).
- Enter connection name and press **Connect**.
- Use the Internet via the newly created dial-up connection.

## How to use as a personal mobile hotspot

- 1 On the **Settings** screen, tap **More**, tap **Tethering & Personal Hotspot** and tap the **Personal Hotspot** switch to activate it.
- 2 Tap **Set up Personal Hotspot** to configure the hotspot name and password.

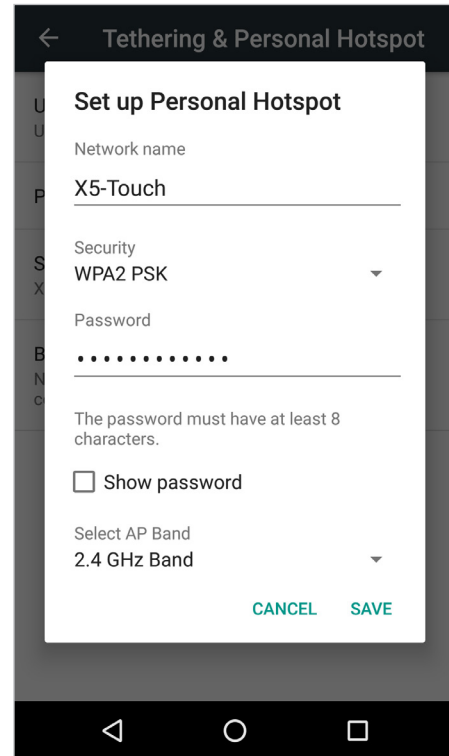
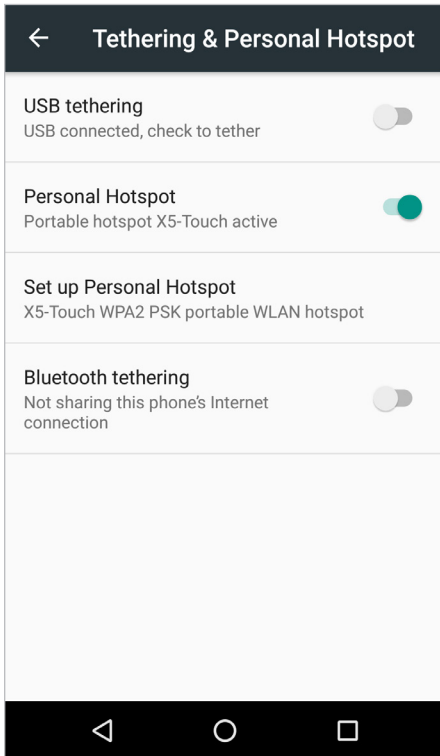

Personal Hotspot can be used to access either Thuraya GmPRS or terrestrial 4G/3G/2G on the remote device.

## How to restrict data services and Wi-Fi

To choose which apps can use data services and Wi-Fi or to restrict certain apps, tap **SIM cards**, tap **Data management** and tap  or  to control Internet access for SAT, GSM and Wi-Fi.

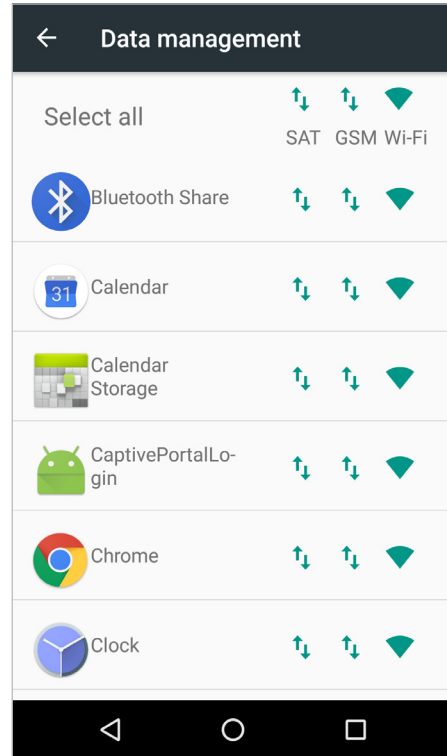
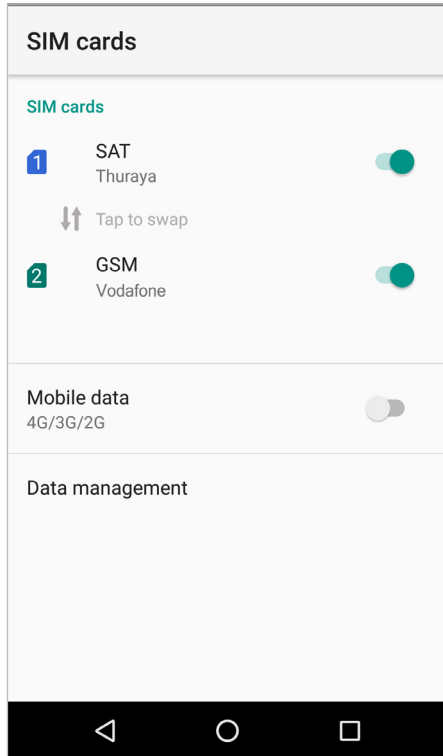

In order to restrict background data, go to **Settings** → **Mobile Data usage** → **Data saver** and tap the **On** switch to activate it. Once activated, apps will only use data if they are in the foreground.

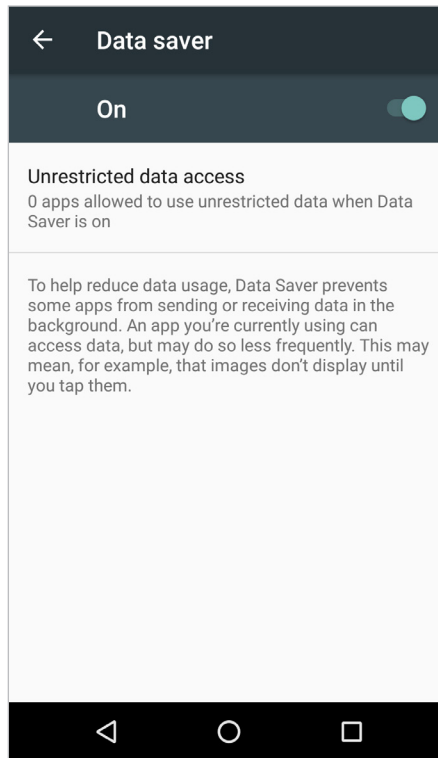

You can set data usage limits in **Settings** → **Mobile Data usage** → **Billing cycle**.

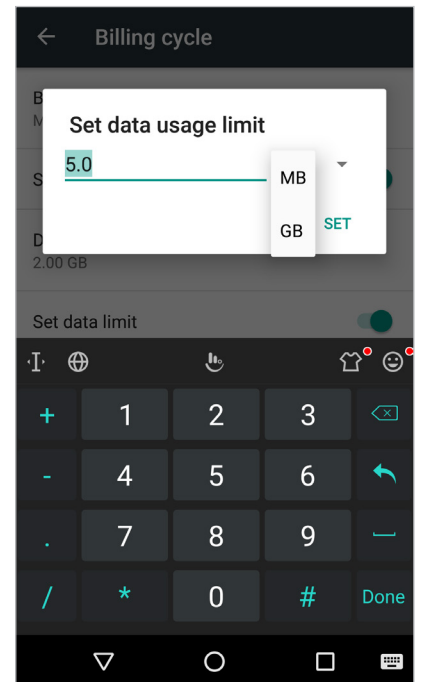
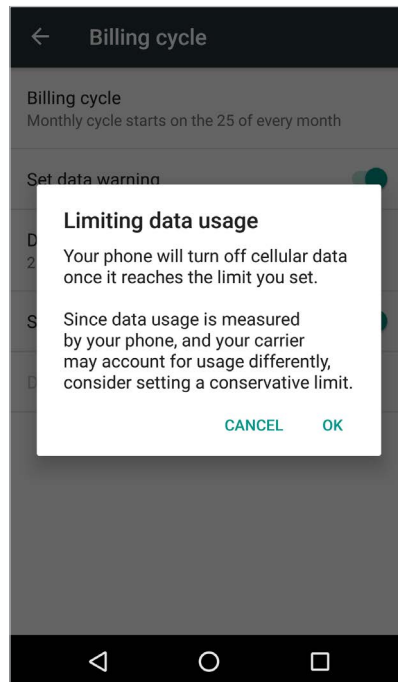
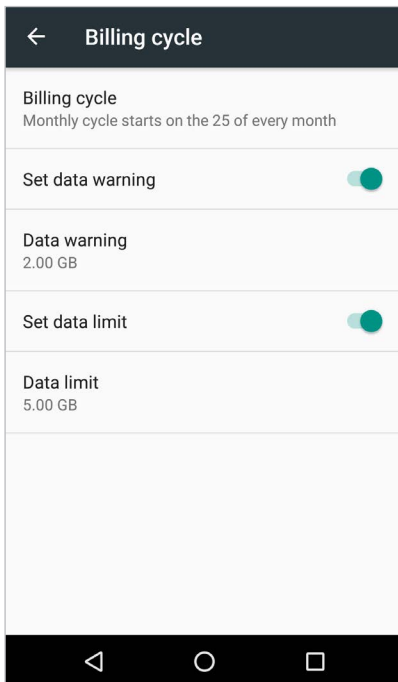



# Display

You can change your screen's brightness, font size, rotation settings, and more. Select a screen mode suitable for viewing movies or images, or adjust the display colour to your preference.



Your Thuraya X5-Touch display can even be used with gloves and if the screen is wet.

# Software update

## Over-the-air (OTA) update

Update your device's software via the firmware over-the-air (FOTA) service. You can also schedule software updates.

On the **Settings** screen, tap **About phone** → **Updates** → **OTA update**.

## SD card update

Another way to update your device's software is via SD card. Please download the latest Thuraya X5-Touch firmware from the Thuraya website and save it in the SD card root directory.

Insert the SD card into the phone, go to **Settings**, tap **About phone** → **Updates** → **SD card update**.



To view the current firmware version of the phone go to **Settings** → **About phone**.

## Multi-function button

Assign the Multi-function button of your Thuraya X5-Touch to:

- 1 Open the Camera
- 2 Start Tracking

## Screen capture

Press and hold the **Volume Down** button and the **Power** button simultaneously. Captured screenshots will be saved in **File manager** → **Pictures** → **Screenshots**.



It is not possible to capture a screenshot while using some apps and features.

# Appendix

## Maintaining your Thuraya X5-Touch

Your phone needs to be in optimal working condition when you need it. To ensure your phone is prepared for satellite use, a regular Thuraya phone test provides you with peace of mind that ensures your phone is working when it is needed:

- Test the satellite connection of your Thuraya phone regularly, especially if you have not used it for some time: dial the free number **11 11 2** in satellite mode from your Thuraya X5-Touch to test if it is working properly (this number can only be accessed with Thuraya SIM cards).
- Charge the Thuraya X5-Touch's battery once a month to have the phone ready when you need it.
- Check your subscription or credit balance regularly.

# Troubleshooting

Before contacting a Thuraya Service Centre, please attempt the following solutions.

## When you turn on your device or while you are using the device, it prompts you to enter one of the following codes:

- Password: When the device lock feature is enabled, you must enter the password you set for the device.
- PIN: When using the device for the first time or when the PIN requirement is enabled, you must enter the PIN supplied with the Thuraya SIM or GSM SIM card. You can disable this feature by using the **Lock SIM card** menu.
- PUK: Your Thuraya SIM or GSM SIM card is blocked, usually as a result of entering your PIN incorrectly several times. To unblock, you must enter the PUK supplied by your service provider.
- PIN2: When you access a menu requiring the PIN2, you must enter the PIN2 supplied with the Thuraya SIM or GSM SIM card. For more information, contact your service provider.

## Your device displays network or service error messages

- When you are in areas with weak signal or poor reception, you may lose reception. Move to another area and try again. While moving, error messages may appear repeatedly.
- You cannot access some options without a valid subscription. For more information, contact your service provider.

## Your device does not turn on

When the battery is completely discharged, your device will not turn on. Charge the battery before turning on the device.

Make sure to maintain the device in a moderate temperature environment. The operating temperature range is between -20 °C and 60 °C.

## The touchscreen responds slowly or improperly

- If you use a screen protector or optional accessories on the touchscreen, ensure that they are installed properly or the touchscreen may not function properly.
- If your hands are not clean while touching the screen, or if you tap the screen with sharp objects or your fingertips, the touchscreen may malfunction.
- Restart your device to clear any temporary software bugs.
- Ensure that your device software is updated to the latest version.
- If the touchscreen is scratched or damaged, visit a Thuraya Service Centre.

## Your device freezes or encounters a fatal error

Try the following solutions. If the problem is still not resolved, contact a Thuraya Service Centre.

### Restarting the device

If your device freezes or hangs, you may need to close apps or turn off the device and turn it on again.

### Force restart

If your device is frozen and unresponsive, press and hold the Power button for more than 7 seconds to restart it.

### Resetting the device

If the methods above do not solve your problem, perform a factory data reset.

Launch the **Settings** app and tap **Backup & reset** → **Factory data reset** → **RESET PHONE**.

Before performing the factory data reset, remember to make backup copies of all important data stored in the device.

If you registered a Google account to the device, you must sign in to the same Google account after resetting the device to access the same information.

## Your device can not find your current location

GPS signals may be obstructed in some locations, such as indoors. Move to a location with unobstructed view of the sky, set the device to use Wi-Fi or a mobile network to find your current location in these situations.

## Data stored in the device has been lost

Always make backup copies of all important data stored in the device. Otherwise, you cannot restore data if it is corrupted or lost. Thuraya is not responsible for the loss of data stored in the device.

## There is not enough space in the device's storage

Delete unnecessary data such as cache or delete unused apps to free up storage space.

## The Home button does not appear

The navigation bar containing the Home button may disappear while using certain apps or features. To view the navigation bar, drag upwards from the bottom of the screen.

## The Thuraya X5-Touch can not connect to the satellite network and 'No Network' is shown on the screen

- Try to update the SAT registration by going to **Settings** → **More** → **Networks** → **SAT registration**.
- Ensure the line of sight to the satellite is not obstructed by high buildings, trees, and mountains.

## "Location update..." is flashing in the widget or the Thuraya X5-Touch shows "Position too old"

The Thuraya X5-Touch's location information is being updated. This is done automatically once the phone is powered on.

## The Thuraya X5-Touch shows 'No SIM'

- Check if the SIM card is dirty or damaged, and try to remove and reinsert the SIM card.
- Check if the SIM card is deactivated or not provisioned for any services. Please contact your service provider for more details.
- Entering a wrong PUK code may deactivate the SIM card.

## The Thuraya X5-Touch becomes unresponsive or sluggish

- Try restarting your phone.
- Do a reset in case your phone has a persistent problem by going to **Settings** → **Backup & reset** → **Factory data reset**.
  - The factory reset will restore the settings on the phone to be as it was when shipped. Personal settings like contacts and messages will be deleted.

## The PIN/PUK codes have been lost or forgotten

- Entering the wrong PIN code 3 times will lock the SIM card. To unlock, you must enter the PUK code.
- After entering the PUK code, you can set a new PIN code.
- In case the PUK code has been forgotten, please contact your service provider.

## 'Add points in consecutive order to form a closed polygon.' is displayed when trying to setup Tracking by Area

The order of the coordinates entered is important. If the order of the coordinates results in a shape with intersecting lines, Tracking by Area will not work.



# Thuraya Short Codes

Use these short codes to access some common services that are available on the Thuraya network (accessible only with Thuraya SIM cards).



## Call services:

Service	Number	Description
Thuraya Customer Care	100	Contact a Thuraya Customer Care representative 24 hours a day.
Thuraya Voicemail Service	123	Access your voicemail and voicemail settings.
Prepaid main menu	150	Access the prepaid main menu to recharge and find out your phone number.
Prepaid account information	151	Prepaid credit balance and validity.
Prepaid scratch card refill	160	Enter 160 [scratch card PIN code] then tap the  icon.
Thuraya Free Test Call Service	11112	Allows you to check if your Thuraya X5-Touch is in working condition and if the subscription is valid.

## SMS services:

Service	Number	Description
SMS Refill Service	150	Refill your prepaid account by sending an SMS to 150 in the following format: # 14-digit scratch card PIN code #.
Satellite locator	1300	From the Navigation app find your current position and send it by SMS to 1300 to obtain location information of the satellite.
Thuraya Call Me Back Service	1755	Send a free notification to another person to call you back. Send the number in the following format to 1755: # destination phone number #.
Twitter SMS Services	1888	Send "start" by SMS to 1888 to activate the service. Once activated you can send tweets by sending an SMS to 1888. Send "Follow[user name]" to follow new accounts.

## USSD services:

Service	Number	Description
Prepaid Refill	*150*scratch card#	Enter *150* [scratch card PIN code] then tap the  icon.
Prepaid billing enquiry	*151#	Enter *151# then tap the  icon.

## Frequency Bands

Item	Frequency Ranges
Satellite	Tx: 1626.5–1660.5 MHz, Rx: 1525–1559 MHz Rated Power: 5 dBW
Wi-Fi	2.4–2.496 GHz 4.9–5.85 GHz
Bluetooth	2.402–2.480 GHz
NFC	13.35 MHz
GNSS	GPS: 1574.42 MHz GLONASS: 1602 MHz + K*562.5 KHz (K=-7,-6,...,5,6) BeiDou: 1561.098 MHz

## Specifications

Item	Frequency Ranges
Network	Satellite, LTE/UMTS/HSPA/GSM
OS	Android 7.1.2 (Nougat)
Chipset	Qualcomm Snapdragon 625 (MSM8953) processor
CPU	Octa-core 2.0 GHz ARM Cortex A53
Memory	Internal: 16 GB, 2 GB RAM External: Up to 32 GB (microSD card)
IP rating	IP67 water and dust protection
MIL standard	Compliant to MIL-STD-810G/F level
Battery	Standby time: up to 100 hours Talk time: up to 13 hours
Cameras	Front: 2MP Rear: 8MP
Sensors	Ambient light photo sensor Accelerometer & Geomagnetic sensor Gyroscope sensor Digital pressure sensor

# Certification / Compliance / Warranty

## SAR Information

Your wireless Thuraya X5-Touch phone is a radio transmitter and receiver. It is designed and manufactured not to exceed the limits for exposure to radio frequency (RF) recommended by international guidelines (ICNIRP). These limits are part of comprehensive guidelines and establish permitted levels of RF energy for the general population. The guidelines include a substantial safety margin designed to assure the safety of all persons, regardless of age and health.

The exposure guidelines for mobile devices employ a unit of measurement known as the Specific Absorption Rate of SAR. The SAR limit stated in the ICNIRP guidelines is 2.0 watts/ kilogram (W/kg) averaged over ten grams of tissue. Tests for SAR are conducted using standard operating positions with the device transmitting at its highest certified power level in all tested frequency bands. The actual SAR level of an operating device can be below the maximum value because the device is designed to use only the power required to reach the network. That amount changes depending on a number of factors such as how close you are to a network base station. The highest SAR value under the ICNIRP guidelines for use of the device at the head and body value is 1.865 W/kg and 1.91 W/kg.

Use of device accessories and enhancements may result in different SAR values. SAR values may vary depending on national reporting and testing requirements and the network band. Additional SAR information may be provided under product information at [www.apsi.co.kr](http://www.apsi.co.kr). Although not intended to support operations when body-worn (in this position the phone can not properly receive and transmit the satellite signal therefore in this mode of operation it is not practical) the use of bodyworn accessories is limited to belt-clips, holsters, or similar accessories that have no metallic component in the assembly and which provide at least 1cm separation between the device, including its antenna, and your body.

## RoHS Compliance

This product is in compliance with EU RoHS Directives and manufactured using lead-free solder paste and parts.

## LIMITED WARRANTY

This Limited Warranty is provided to the original end-user purchaser (the 'Buyer') of any new Thuraya X5-Touch Handheld Phone. This Limited Warranty is non-transferable.

### Warranty Coverage and Service

Thuraya warrants all new Thuraya X5-Touch Handheld Phones (the 'Product') under normal use and wear to be free from defects in material and workmanship for a period of one (1) year from the date of purchase by the original Buyer (the 'Warranty Period'). If, under normal use and wear, the Product becomes defective in materials or workmanship and is returned at Buyer's expense to a Thuraya Authorized Service Center during the Warranty Period, the Product will be repaired or replaced at no charge to the Buyer. The Buyer will be required to provide reasonable proof of date of purchase.

Reconditioned replacement components, parts, units or materials may be used if the Product is repaired or replaced. Costs incurred in the removal, de-installation or reinstallation of the Product are not covered.

THIS LIMITED WARRANTY DOES NOT COVER AND THURAYA WILL NOT BE RESPONSIBLE FOR THE FOLLOWING:

This Limited Warranty will be void in its entirety if the Product is serviced by anyone other than Thuraya or a Thuraya Authorized Service Centre. Buyer's sole and exclusive remedy shall be the repair or replacement of the defective product, as specifically described above.

Thuraya neither assumes nor authorizes any Authorized Service Centre or any other person or entity to assume any other obligation or liability beyond that which is provided for in this Limited Warranty.

This Limited Warranty is conditioned upon proper use of the Product and does not cover the following:

- products or accessory equipment not manufactured or provided by Thuraya
- failures or defects caused by misuse, abuse, accident, alteration, dampness, sand, unusual physical, electrical or electromechanical stress or neglect

- unauthorized installation, removal or repair
- failure to follow instructions
- fire, flood or other nature caused accidents
- spills of food or liquids; moisture
- normal wear and tear
- scratches, dents and cosmetic damage
- improper installation, maintenance or improper storage
- performance of the Product when used in combination with other products or equipment not manufactured or provided by Thuraya
- payments for labor or service to representatives or service centers not authorized by Thuraya

This limited Warranty of the Product does not cover the operation, availability, coverage, range or grade of service provided by the satellite systems.

## Limitation of Liability

THIS LIMITED WARRANTY IS IN LIEU OF ALL OTHER WARRANTIES, WHETHER EXPRESSED, IMPLIED OR STATUTORY, INCLUDING, WITHOUT LIMITATION, THE IMPLIED WARRANTIES OF MERCHANTABILITY AND FITNESS FOR A PARTICULAR PURPOSE. THURAYA SHALL NOT BE LIABLE FOR DAMAGES IN EXCESS OF THE PURCHASE PRICE OF THE PRODUCT, LESS REASONABLE AMOUNT FOR USE AND WEAR, OR FOR ANY INCIDENTAL, SPECIAL, PUNITIVE OR CONSEQUENTIAL DAMAGES OF ANY NATURE WHATSOEVER, OR FOR ANY DELAYS, LOSS OF USE, TIME, PROFITS, REVENUE OR SAVINGS, ANY COMMERCIAL LOSS, INCONVENIENCE, MILEAGE, DAMAGE TO BUYER'S OR TO OTHER PERSON'S VEHICLE OR ANY OTHER PROPERTY, ARISING FROM THE USE OR INABILITY TO USE THE PRODUCT, OR OTHERWISE FOR ANY FAILURE TO PERFORM.

All liability and obligations of Thuraya under this Limited Warranty shall terminate upon the expiration of the applicable Warranty Period provided herein. This Limited Warranty sets forth the entire responsibility of Thuraya with respect to the Product. There are no other liabilities of Thuraya arising from the sale of the Product whether based on warranty, contract, negligence or other theories of liability. No employee, agent, dealer, representative, distributor, service partner or reseller is authorized to modify or extend this Limited Warranty or to make binding representations, whether in advertising, presentations or otherwise, in the name and/or on behalf of Thuraya regarding the Product or this Limited Warranty.

In no event shall Thuraya liability exceed the cost of correcting defects as provided herein.

This Limited Warranty gives specific legal rights to Buyer, and Buyer also may have other rights which may vary from jurisdiction to jurisdiction, as this Limited Warranty does not affect the Buyer's legal rights under the relevant applicable national laws in respect of the sale of consumer goods or the Buyer's rights vis-a-vis the retail seller/dealer of the Product.

Asia Pacific Satellite Inc (APSI), a company duly incorporated and validly existing under the laws of South Korea, hereby declares that the Product is in compliance with the essential requirements and other relevant provisions of Directive 1999/5/EC, Directive 2013/35/EC and EU RoHS Directives, as well as any other applicable regulations, including but not limited to those related to (i) telecommunications terminal equipment; (ii) use of hazardous substances in electrical and electronic equipment; and (iii) safety requirements in respect of electromagnetic fields which are in force in the countries listed in the Appendix A of the warranty service program for the Product at the moment this Limited Warranty is issued. In addition, the Product complies with international standards and specifications (among others, the CE marking and the ITU GMPCS MoU mark).



The crossed-out wheeled bin means that within the European Union the product must be taken to separate collection at the product end-of-life. Do not dispose of these products as unsorted municipal waste.

THURAYA trademark is the sole and exclusive property of Thuraya Telecommunications Company.

Copyright© 2019 Thuraya Telecommunications Company. All rights reserved.

This manual is published by Thuraya Telecommunications Company without any warranty. Thuraya Telecommunications Company reserves the right to make changes and improvements to any of the products described in this manual without prior notice.

No reproduction in whole or in part allowed without Thuraya's prior written approval.

If any part of this Limited Warranty is held to be illegal or unenforceable, such partial illegality or unenforceability shall not affect the enforceability of the remainder of the limited warranty.

## Trademarks

- THURAYA and the THURAYA logo are registered trademarks of Thuraya Telecommunications Company.
- Bluetooth® is a registered trademark of Bluetooth SIG, Inc. worldwide.
- Wi-Fi® and the Wi-Fi logo are registered trademarks of the Wi-Fi Alliance.
- All other trademarks and copyrights are the property of their respective owners.
- Android is a trademark of Google.